



Part of **Easy** series

Easy TeSys

Motor starters from 6 A to 630 A

Catalog 2025



se.com

Life Is On

Schneider
Electric

100 years of leadership in motor starter technology

Easy TeSys provides you **Essential** control and protection for your applications.



HVAC



GenSet

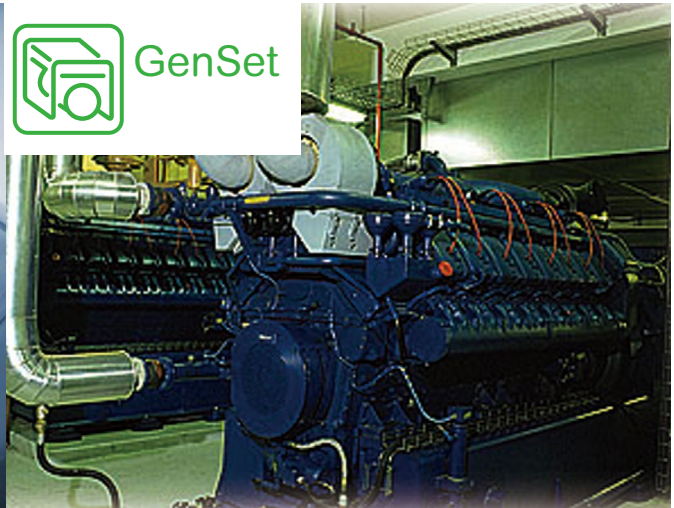

Pumps



Textile



Material Handling



Packaging



Two principles to build your starter solution

Designed for the essential

2-components solution

(Thermal-magnetic circuit breaker + Contactor)

Power and motor protection

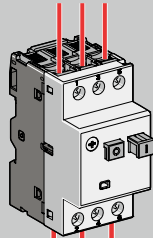

Thermal-magnetic circuit breaker

3-components solution

(Magnetic circuit breaker or fuse + Contactor + TOR)

Power protection

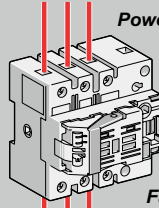

Fuse

or

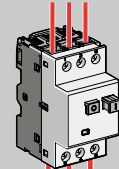

Magnetic circuit breaker

Motor control

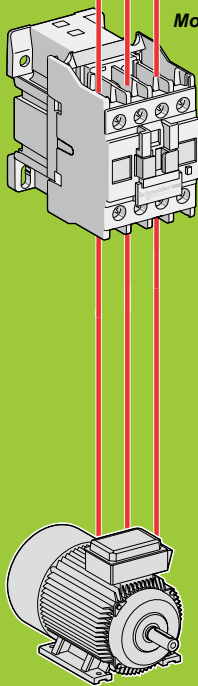

Motor control and protection

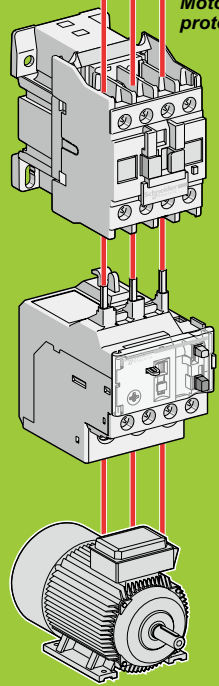

To build the essential solutions
in an easy and simple way

Control

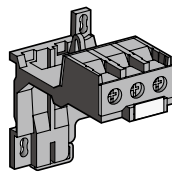
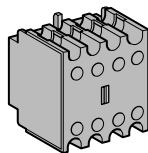

Terminal block

Reverser starter

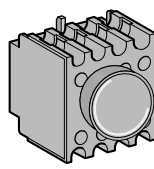
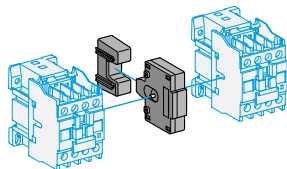

Star-Delta solution

> Easy choice for
simple applications

General contents

Easy TeSys Control

Contactors 6 A to 630 A

A

Easy TeSys Control

Control Relays 4 NO/NC contacts

B

Easy TeSys Protect

Thermal Overload Relays 0.1 A to 630 A

C

Easy TeSys Power

Motor Circuit Breakers 0.1 A to 32 A

D

Easy TeSys -Device Selection

Coordination tables

Glossary, Definitions, Technical Information

E

Easy TeSys



> **Easy TeSys Control**
Contactors, 6 A to 630 A



> **Easy TeSys Control**
Control Relays, 4 NO/NC Contacts



> **Easy TeSys Protect**
Thermal Overload Relays, 0.1 A to 630 A

CPB100407



> **Easy TeSys Power**
Motor Circuit Breakers, 0.1 A to 32 A

Easy TeSys -Device Selection

- > Coordination tables
- > Glossary, Definitions, Technical Information

Control your motors, Do It Yourself simply your solution:
direct-on-line starter, reversing starter, star-delta starter

- 3 pole and 4 pole Characteristics ▶ A-1
- Accessories, spare parts ▶ A-22
- Dimensions, mounting ▶ A-30

Pilot your control circuits

- Characteristics ▶ B-2
- Dimensions, mounting ▶ B-5

Footprint for complete compatibility with contactors
(direct mounting under contactors)

- Characteristics ▶ C-4
- Dimensions, mounting ▶ C-8

- Presentation ▶ D-3
- Characteristics ▶ D-5
- References ▶ D-7
- Dimensions, mounting ▶ D-12

Better continuity of service

- Coordination tables ▶ E-1
- Glossary ▶ E-6
- Definitions ▶ E-7
- Technical informations ▶ E-8

Easy TeSys Control-Contactors

3-pole from 6 A to 630 A

Size		1	2	3							
Rated operational current AC-3	A	6	9	12	18	25	32	38	40		
	A	6	9	12	18	25	32	38	40		
	A	20	25	25	32	32	50	50	60		
Rated operational current AC-1	kW	1.1	2.2	3	4	5.5	7.5	9	11		
		2.2	4	5.5	7.5	11	15	18.5	18.5		
		2.2	4	5.5	9	11	15	18.5	22		
		3	4	5.5	9	11	15	18.5	22		
		3	4	5.5	9	11	15	18.5	30		
Rated operational power in AC-3	mm	1.1	2.2	3	4	5.5	7.5	9	11		
		2.2	4	5.5	7.5	11	15	18.5	18.5		
		2.2	4	5.5	9	11	15	18.5	22		
		3	4	5.5	9	11	15	18.5	22		
		3	4	5.5	9	11	15	18.5	30		
Rated operational power in AC-3e	mm	1.1	2.2	3	4	5.5	7.5	9	11		
		2.2	4	5.5	7.5	11	15	18.5	18.5		
		2.2	4	5.5	9	11	15	18.5	22		
		3	4	5.5	9	11	15	18.5	22		
		3	4	5.5	9	11	15	18.5	30		
Width	AC	45			45.5			56		75	
	DC	45			45			45		75	
Coil rated operating voltage		24...440 V AC and 24V DC according to the coil voltage code (see below)									
Auxiliary built in contact		1 NO or 1 NC									

References ⁽¹⁾	LC1E06	LC1E09	LC1E12	LC1E18	LC1E25	LC1E32	LC1E38	LC1E40
---------------------------	--------	--------	--------	--------	--------	--------	--------	--------

(1) Partial, see below.

Utilisation categories

- > Class AC-1: AC loads with $\cos \phi$ at least equal to 0.95 (resistive load, heating, distribution, etc.).
- > Class AC-3: squirrel-cage motors with breaking taking place with the motor running.
- > Class AC-3e: high-efficiency IE3/ IE4 squirrel cage motors with breaking taking place with the motor running.

Coil voltage code for 3-pole contactors

		24	48	110	220	230	240	380	415	440
LC1E06-300	50 Hz	B5	E5	F5	M5	-	U5	Q5	N5	R5
	60 Hz	B6	-	F6	M6	-	-	Q6	-	R6
LC1E06-95	50/60Hz	B7	E7	F7	M7	P7	-	Q7	-	-
	DC	BD	-	-	-	-	-	-	-	-
LC1E120-300	50/60Hz	-	-	F7	M7	-	U7	Q7	-	-
LC1E400-630	50/60Hz	-	E7	F7	M7	-	U7	Q7	N7	R7

Contactors: how to determine the full commercial reference ?

Example:

LC1E	12	10	U	5		ref. LC1E1210U5	
					5	50 Hz	
						Coil voltage code	240 V
						Auxiliary contact configuration ⁽²⁾	01 1NC 10 1NO
						Rated operation current AC3	12 A
						Contactors	Easy Tesys

(2) Example up to LC1E38 for details, please consult page A-4

Easy TeSys Control-Contactors

3-pole from 6 A to 630 A

		4		5		6		7		8		9	
50	65	80	95	120	160	200	250	300	400	500	630		
50	65	80	95	96	100	175	190	265	330	400	500		
70	80	110	120	150	200	250	300	320	500	700	1000		
11	18.5	22	22	37	45	55	75	90	110	147	185		
22	30	37	45	55	75	90	132	160	200	250	335		
22	37	45	45	59	80	100	140	160/185	220/250	280/295	375/400		
30	37	45	45	75	90	110	160	200	257	355	400		
30	37	45	45	80	100	110	160	220	280	335	450		
11	18.5	22	22	22	30	45	55	75	90	110	150		
22	30	37	45	45	45	90	90	132	160	200	250		
22	37	45	45	55	55	90	110	150/160	185/200	220/250	295/315		
30	37	45	45	65	65	110	132	180	220	265	355		
30	37	45	45	75	80	110	132	180	220	265	355		
		85		120		168.5		213	213	233	309		
		85		/									
1 NO + 1 NC						-	-						

LC1E50	LC1E65	LC1E80	LC1E95	LC1E120	LC1E160	LC1E200	LC1E250	LC1E300	LC1E400	LC1E500	LC1E630
--------	--------	--------	--------	---------	---------	---------	---------	---------	---------	---------	---------

Accessories

> Compatible with AC contactor



LAERC●● RC switch suppressor (up to 95 A)

(see page A-23)



LAEM● mechanical interlock

(see page A-22)



LAEP● set of power connections (up to 95 A)

(see page A-22)

> Compatible with DC contactor:



LA4D●● suppressor (40 to 95 A)

(see page A-23)



LAD9V2 mechanical interlock (up to 38A)

(see page A-22)



LAD9R1 mechanical interlock with set of power connection (up to 38A)

(see page A-22)

> Common Compatible with:



LAEN● auxiliary contact blocks

(see page A-24)



LAETSD time delay auxiliary contact (from 25 A contactor)

(see page A-24)

Easy TeSys Control

Contactors - 4 Pole from 6 A to 95 A

Size	1				2			3		4	
Rated operational current AC-3	A 6 9 12 18				25 32 38			40 65		80 95	
Rated operational current AC-1	A 16 20 25 32				40 45 50			60 80		100 125	
Width	mm 45				56			84.5		95.5	
Coil rated operating voltage	24...415 V AC according to the coil voltage code (see below)										
Auxiliary built in contact	no built in contact										

References ⁽¹⁾	LC1E06	LC1E09	LC1E12	LC1E18	LC1E25	LC1E32	LC1E38	LC1E40	LC1E65	LC1E80	LC1E95
---------------------------	--------	--------	--------	--------	--------	--------	--------	--------	--------	--------	--------

(1) Partial, see below.

Coil voltage code for 4-pole contactors

	24	48	110	220	230	240	380	400	415	
LC1E06-95	50/60Hz	B7	E7	F7	M7	P7	U7	Q7	V7	N7

Common characteristics

> Contactors compatible with:



LAEN● auxiliary contact blocks (see page A-24)



LAETSD time delay auxiliary contact (from 25 A contactor) (see page A-24)



LAERC●● RC switch suppressor (up to 95 A) (see page A-23)

Contactor: how to determine the full commercial reference ?

Example:

LC1E 12 004 B 7	ref. LC1E12004B7
7	50/60Hz
Coil voltage code	24V
Main Contact	004 4NO 008 2NO+2NC
Rated operation current AC3	12 A
Contactor	Easy Tesys

Example 1: You need a 32 A contactor, 4 NO contact, 24 V - 50/60Hz coil ⇒ **LC1E32004B7**

Example 2: You need a 95A contactor, 2NO+2NC contact, 220 V - 50/60Hz coil ⇒ **LC1E95008M7**

Commercial Reference Numbering System

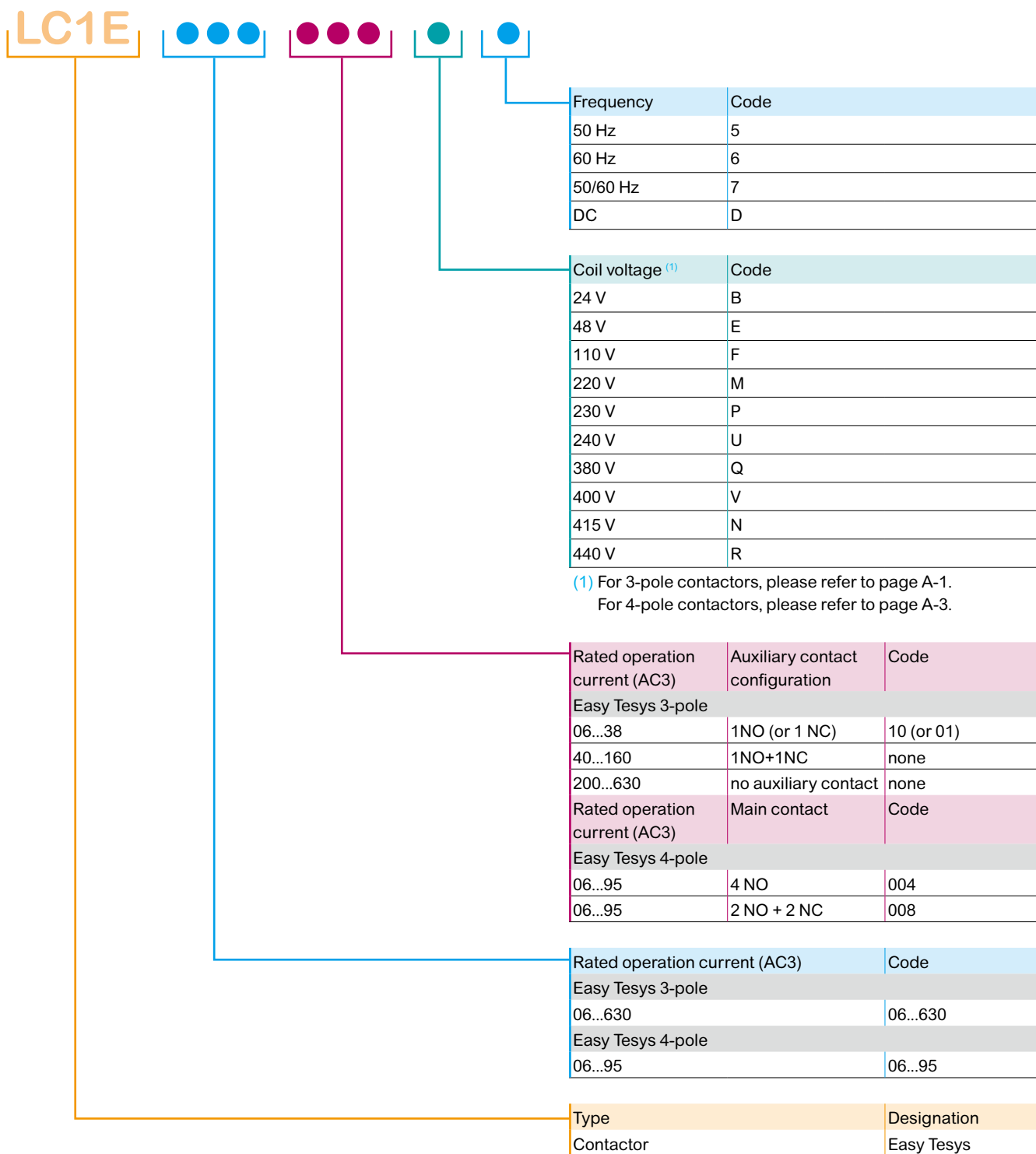

Contactor: how to determine the full commercial reference?

Example 1: You need a 32 A contactor, 1 NC auxiliary contact, 24 V - 50 Hz coil ⇒ **LC1E3201B5**

Example 2: You need a 120 A contactor, 1 NC + NO auxiliary contact, 220 V - 50 Hz coil ⇒ **LC1E120M5**

Easy TeSys Control

Contactors- 3 pole from 6 A to 630 A Power Characteristics

Pole Characteristics				LC1E06	LC1E09	LC1E12	LC1E18
Contactor type							
Number of poles				3			
Rated operational current (Ie) (Ue ≤ 440 V)	In AC-3 (θ ≤ 55°C)	A	6	9	12	18	
	In Ac-3e(θ ≤ 55°C)		6	9	12	18	
	In AC-1 (θ ≤ 55°C)		20	25		32	
	In AC-1 (θ ≤ 40°C)		-				
Rated operational voltage (Ue)	Up to	V	690				
Frequency limits	Of the operational current	Hz	50/60				
Conventional thermal current (Ith)	θ ≤ 55°C	A	20	25		32	
	θ ≤ 40°C		-				
Rated breaking capacity at 440 V	Conforming to IEC 60947	A	51	76.5	102	153	
Rated making capacity at 440 V	Conforming to IEC 60947-4-1	A	78	117	156	234	
Permissible short time rating No current flowing for preceding 15 minutes with θ ≤ 40°C	10 s	A	80	105		145	
	1 min		45	61		84	
	10 min		20	30		40	
Maximum permissive current No current flowing for previous 60 minutes, at θ ≤ 40°C	For 10 s	A	-				
Protection by fuses against short-circuits (U ≤ 690 V)	Without thermal overload relay gG fuse Type 1	A	12	20	25	35	
	With thermal overload relay		For corresponding aM or gG fuse ratings corresponding to the associated LRE thermal overload relay, please see page B-3				
Average impedance per pole	At Ith and 50 Hz	mΩ	2.5				
Power dissipation per pole for the above operational currents	AC-3	W	0.09	0.20	0.36	0.81	
	AC-1		1.0	1.6		2.6	
Electrical durability	AC-3 (Ue ≤ 440 V)	Million cycles	1.4			1.2	
	AC-1 (Ue ≤ 440 V)		0.15			0.3	
Mechanical durability			10				

Power Circuit Connections				LC1E06	LC1E09	LC1E12	LC1E18
Contactor type							
Connection maximum c.s.a.							
Flexible cable with cable end	1 conductor	mm ²	1...4				
	2 conductors		1...2.5				
Flexible cable without cable end	1 conductor	mm ²	1...4			1.5...6	
	2 conductors		1...4			1.5...6	
Solid cable without cable end	1 conductor	mm ²	1...4			1.5...6	
	2 conductors		1...4			1.5...6	
Cable with lug		mm	-				
Bar	Number of bars		-				
	Bar	mm x mm	-				
Bolt diameter	1 conductor	mm	-				
Tightening torque with AC Coil	Power circuit connection	N.m	1.2 ~ 1.4				
Tightening torque with DC Coil	Power circuit connection	N.m	1.6 ~ 1.8				
Tool			Philips N°2 or Pozidriv N°2 or Ø6mm flat				

	LC1E25	LC1E32	LC1E38	LC1E40	LC1E50	LC1E65	LC1E80	LC1E95	LC1E120	LC1E160	LC1E200	LC1E250	LC1E300	LC1E400	LC1E500	LC1E630
	25	32	38	40	50	65	80	95	120	160	200	250	300	400	500	630
	25	32	38	40	50	65	80	95	96	100	175	190	265	330	400	500
	32	50		60	70	80	110	120	–							
									150	200	250	300	320	500	700	1000
	32	50		60	70	80	110	120	–							
									150	200	250	300	320	500	700	1000
	212.5	272	323	340	425	552.5	680	807.5	960	1280	1600	2000	2400	3200	4000	5040
	325	416	494	520	650	845	960	1140	1200	1600	2000	2500	3000	4000	5000	6300
	240	260	310	320	400	520	640	800	950	1200	1500	1800	2650	3600	4200	5050
	120	138	150	165	208	260	320	400	550	580	740	850	1300	1700	2400	3400
	50	60		72	84	110	135		250	250	400	440	750	1000	1200	1600
									1100	1400	1500	1800	2650	3600	4200	5050
	40	63		80	100	125	160		250	315			500	630	800	800
									–							
	2.5			1.5		1	0.8		0.6		0.33	0.32	0.3	0.26	0.18	0.12
	1.6	2.0	2.9	2.4	3.8	4.2	5.1	7.2	8.6	15	13	20	27	42	45	48
	3.2	5.0		5.4	7.4	6.4	9.7	12	14	24	21	29	31	65	88	120
		1	0.9						0.8		0.5	0.7	0.5	0.6	0.6	0.6
	0.35								0.25		0.2		0.4	0.25	0.25	0.2
		8		5			3		4		5			4	4	4

	LC1E25	LC1E32	LC1E38	LC1E40	LC1E50	LC1E65	LC1E80	LC1E95	LC1E120	LC1E160	LC1E200	LC1E250	LC1E300	LC1E400	LC1E500	LC1E630
	1...6			2.5...25			4...50		10...120							
	1...4			2.5...10			4...16		10...120 + 10...50							
		1.5...10		2.5...25			4...50		10...120							
		1.5...6		2.5...16			4...25		10...120 + 10...50							
		1.5...10		2.5...25			4...50		10...120							
		1.5...6		2.5...16			4...25		10...120 + 10...50							
										150	185	240	2 x 150	2 x 240	–	
										2						
										3 x 25	4 x 32	5 x 30	30 x 5	40 x 5	60 x 5	
										M8	M10				M12	
	1.7 ~ 2.0	1.85 ~ 2.15		5 ~ 5.8			12 ~ 13.5		12 ~ 13.5		18 ~ 21	35 ~ 37				58 ~ 60
	1.6 ~ 1.8	2.4 ~ 2.7		5 ~ 5.8			12 ~ 13.5		/		/	/				/
				Ø8mm flat			Allen key n°4		Allen key n°4		Wrench					

Easy TeSys Control

Contactors- 4 pole from 6 A to 95 A

Power Characteristics

Pole Characteristics				LC1E06	LC1E09	LC1E12	LC1E18
Contactor type							
Number of poles				4			
Rated operational current (Ie) (Ue ≤ 415 V)	In AC-3 (θ ≤ 55°C)	A	6	9	12	18	
	In AC-1 (θ ≤ 55°C)		16	20	25	32	
Rated operational voltage (Ue)		V	690				
Frequency limits		Hz	50/60				
Conventional thermal current (Ith)		A	16	20	25	32	
Rated breaking capacity at 440 V		A	48	72	96	144	
Rated making capacity at 440 V		A	60	90	120	180	
Permissible short time rating No current flowing for preceding 15 minutes with θ ≤ 40°C	10 s	A	80	105		145	
	1 min		45	61		84	
	10 min		20	30		40	
Maximum permissive current No current flowing for previous 60 minutes, at θ ≤ 40°C		A	-				
Protection by fuses against short-circuits (U ≤ 690 V)	Without thermal overload relay gG fuse Type 1	A	12	20	25	35	
	With thermal overload relay		For corresponding aM or gG fuse ratings corresponding to the associated LRE thermal overload relay, please see page B-3				
Average impedance per pole		mΩ	2.5				
Power dissipation per pole for the above operational currents		W	1.0	1.6		2.6	
Electrical durability		Million cycles	0.15		0.3		
Mechanical durability			10				

Power Circuit Connections				LC1E06	LC1E09	LC1E12	LC1E18
Contactor type							
Connection maximum c.s.a.							
Flexible cable with cable end	1 conductor	mm²	1...4				
	2 conductors		1...2.5				
Flexible cable without cable end	1 conductor	mm²	1...4				1.5...6
	2 conductors		1...4				1.5...6
Solid cable without cable end	1 conductor	mm²	1...4				1.5...6
	2 conductors		1...4				1.5...6
Cable with lug		mm	-				
Bar	Number of bars		-				
	Bar	mm x mm	-				
Bolt diameter	1 conductor	mm	-				
Tightening torque		N.m	1.2				
Tool			Philips N°2 or Pozidriv N°2 or Ø6mm flat				

	LC1E25	LC1E32	LC1E38	LC1E40	LC1E65	LC1E80	LC1E95
	25	32	38	40	65	80	95
	40	45	50	60	80	100	125
	40	45	50	60	80	100	125
	200	256	304	320	520	640	760
	250	320	380	400	650	800	950
	240	260	310	320	520	640	800
	120	138	150	165	260	320	400
	50	60		72	110	135	
	40	63		80	125	160	
	2.5			1.5	1	0.8	
	3.2	5.0	5.4	5.4	6.4	9.7	12
	0.35						
		8		5		3	
	LC1E25	LC1E32	LC1E38	LC1E40	LC1E65	LC1E80	LC1E95
	1...6			2.5...25		4...50	
	1...4			2.5...10		4...16	
	1.5...10			2.5...25		4...50	
	1.5...6			2.5...16		4...25	
	1.5...10			2.5...25		4...50	
	1.5...6			2.5...16		4...25	
	1.5	2.1		5		12	
				Ø8mm flat		Allen key n°4	

Easy TeSys Control

Contactors - 3-pole from 6 A to 630 A

Control Circuit: Coil Characteristics
Built in Auxiliary Contact

Control Circuit: Coil Characteristics with AC Supply

Contactor type				LC1E06	LC1E09	LC1E12	LC1E18
Rated control circuit voltage (Uc) 50/60 Hz				V	24...440 according coil voltage code		
Control voltage limits ($\theta \leq 55^\circ\text{C}$)							
50/60 Hz coils	Operational				0.85...1.1 Uc		
	Drop-out				0.3...0.6 Uc		
Average consumption at 20°C and at Uc							
~ 50 Hz	Inrush	50/60 Hz coils	VA	95			
			cos φ	0.75			
	Sealed	50/60 Hz coils	VA	8.3			
			cos φ	0.3			
~ 60 Hz	Inrush	50/60 Hz coils	VA	95			
			cos φ	0.75			
	Sealed	50/60 Hz coils	VA	8.5			
			cos φ	0.3			
Heat dissipation 50/60 Hz coils				W	2...3		
Operating time 50/60 Hz coils	Closing "C"			ms	12...22		
	Opening "O"				4...19		
Maximum operating rate at ambient temperature $\leq 55^\circ\text{C}$				In operating cycles per hour	1800		

Control Circuit: Coil Characteristics with DC Supply

Contactor type				LC1E06	LC1E09	LC1E12	LC1E18
Rated control circuit voltage (Uc)				V	24.		
Control voltage limits ($\theta \leq 55^\circ\text{C}$)							
Operational					0.85...1.1 Uc		
Drop-out					0.1...0.25 Uc		
Average consumption at 20°C and at Uc							
	Inrush	coil	W	6			
			Sealed	Coil	W	6	
Operating time	Closing "C"			ms	53...72		
	Opening "O"				16...24		
Maximum operating rate at ambient temperature $\leq 55^\circ\text{C}$				In operating cycles per hour	1800		
time constant (L/R)				ms	28		

Easy TeSys Control

Contactors - 3-pole from 6 A to 630 A

Control Circuit: Coil Characteristics
Built in Auxiliary Contact

Control Circuit Connections						
Contactor type			LC1E06	LC1E09	LC1E12	LC1E18
Connection maximum c.s.a.						
Flexible cable without cable end	1 or 2 conductors	mm ²	1...4			
Flexible cable with cable end	1 conductor	mm ²	1...4			
	2 conductors		1...2.5			
Solid cable without cable end	1 or 2 conductors	mm ²	1...4			
Tightening torque	with AC coil	N.m	1.2			
	with DC coil	N.m	1.7			
Screwdriver			Philips N° 2 or Pozidriv N°2 or Ø6 mm flat			
Built in Auxiliary Contact						
Contactor type			LC1E06	LC1E09	LC1E12	LC1E18
Contacts conforming to	IEC 60947-5-1		LC1E06...E38: contactor's own 1NO or 1NC LC1E40...E160: contactor's own 1NO and 1NC			
Rated operational voltage (Ue)	Up to	V	690			
Rated insulation voltage (Ui)	Conforming to IEC 60947-1		690			
Conventional thermal current (Ith)	Ambient air temperature ≤ 60 °C	A	10			
Operating current frequency		Hz	50/60			
Minimum switching capacity $\lambda = 10^{-8}$	U min	V	17			
	I min	mA	5			
Short-circuit protection	Conforming to IEC 60947-5-1		gG fuse: 10 A			
Raked making capacity	Conforming to IEC 60947-5-1	A	~: 140			
Short-time rating	Permissible for 1 s		100			
		500 ms	120			
		100 ms	140			
Insulation resistance		mΩ	>10			
Non-overlap time	Guaranteed between N/C and N/O contacts	ms	1.5 on energisation and on de-energisation			

Easy TeSys Control

Contactors- 4-pole from 6 A to 95 A

Control Circuit: Coil Characteristics

Built in Auxiliary Contact

Control Circuit: Coil Characteristics with AC Supply

Contactor type				LC1E06	LC1E09	LC1E12	LC1E18
Rated control circuit voltage (Uc) 50/60 Hz				V	24...415 according coil voltage code		
Control voltage limits ($\theta \leq 55^\circ\text{C}$)							
50/60 Hz coils	Operational			0.85...1.1 Uc			
	Drop-out			0.3...0.6 Uc			
Average consumption at 20°C and at Uc							
~ 50 Hz coils	Inrush	coil	VA	95			
		cos φ		0.75			
	Sealed	coil	VA	8.5			
		cos φ		0.3			
~ 60 Hz coils	Inrush	coil	VA	95			
		cos φ		0.75			
	Sealed	coil	VA	8.5			
		cos φ		0.3			
Heat dissipation				W	2.3		
Operating time		Closing "C"	ms	12...22			
		Opening "O"		4...19			
Maximum operating rate at ambient temperature $\leq 60^\circ\text{C}$				In operating cycles per hour	1800		

Control Circuit Connections

Contactor type				LC1E06	LC1E09	LC1E12	LC1E18
Connection maximum c.s.a.							
Flexible cable without cable end	1 or 2 conductors		mm ²	1...4			
Flexible cable with cable end	1 conductor		mm ²	1...4			
	2 conductors			1...2.5			
Solid cable without cable end	1 or 2 conductors		mm ²	1...4			
Tightening torque				N.m	1.2		
Screwdriver					Philips N° 2 or Pozidriv N°2 or Ø6 mm flat		

	LC1E25	LC1E32	LC1E38	LC1E40	LC1E65	LC1E80	LC1E95
	95			160		200	
	8.3			15		20	
	95			140		220	
	8.3			13		22	
				6...10			
				20...26		20...35	
				8...12		6...20	
				1200			

	LC1E25	LC1E32	LC1E38	LC1E40	LC1E65	LC1E80	LC1E95

Easy TeSys Control

Contactors - 3-pole from 6 A to 630 A

Environment				
Contactor type			LC1E06...E18	LC1E25...E38
Rated insulation voltage (Ui)	Conforming to IEC 60947-4-1, overvoltage category III, degree of pollution: 3	V	690	
Rated impulse withstand voltage (Uimp)	Conforming to IEC 60947	kV	6	
Conforming to standards			IEC 60947-4-1, IEC 60947-5-1	
Product certifications			CB Scheme, CE, CCC, EAC	
Degree of protection (front face only)	Conforming to IEC 60529		Protection against direct finger contact IP20	
Protective treatment	Conforming to IEC 60068-2-30		IEC60068-2-30 Test Db, Variant 2	
Ambiant air temperature around the device	Storage	°C	-60...+80	
	Operation		-5...+55	
	Permissible at UC ⁽¹⁾		-20...+70	
Maximum operating altitude	Without derating	m	3000	
Operating positions	Without derating		±30° in relation to normal vertical mounting plane	
Flame resistance	Conforming to IEC 60695-2-11	°C	850	
Shock resistance ⁽³⁾	Conforming to	Contactor open (AC)	7 gn	6 gn
		Contactor open (DC)	5 gn	5 gn
1/2 sinewave = 11 ms	IEC 60068-2-27	Contactor closed	10 gn	
Vibration resistance ⁽³⁾	Conforming to	Contactor open	1.5 gn	
		Contactor closed	3 gn	

(1) Derating see page E-6.

(2) For use in upside down, please consult your local Schneider Electric office.

(3) Without change of contact states, in the most unfavorable direction (coil energised at Ue).

Installation Recommendations



Avoid fire, product damage, or power loss with a safe enclosure

Severe conditions such as dust, humidity, high temperature can result in people or equipments exposed to serious risks if suitable protection of the electrical components is not considered.

Spacial CRN steel enclosures is one of our solutions

A complete offer with 39 dimensions from 200 x 200 x 150 mm to 1000 x 800 x 300 mm:

- with plain door, without plain mounting plate
- with plain door and plain mounting plate
- with glazed door, without plain mounting plate
- Degree of protection IP 66
- Compliance with standard IEC 62208
- A wide range of accessories to fit to all your applications

Spacial CRN, suitable for any application

Indoors with harsh and dirty environments like machines, manufacturing plants, and logistic centers.

Specific optional devices re-enforce the protection:

- fans
- filters

LC1E40...E65	LC1E80...E95	LC1E120...E160	LC1E200...E300	LC1E400	LC1E500	LC1E630
			8			
			IEC 60947-4-1			
			IP00			
			-			
				6gn	9gn	6gn
6 gn	/					
7 gn			15gn			
				1.5gn	2gn	
				5gn	4gn	

Easy TeSys Control Contactors - 4-pole from 6 A to 95 A

Environment				LC1E06...E18	LC1E25...E38
Contactor type					
Rated insulation voltage (Ui)	Conforming to IEC 60947-4-1, overvoltage category III, degree of pollution: 3	V	690		
Rated impulse withstand voltage (Uimp)	Conforming to IEC 60947	kV	6		
Conforming to standards			IEC 60947-4-1, IEC 60947-5-1		
Product certifications			CB Scheme, CE, CCC, EAC		
Degree of protection (front face only)	Conforming to IEC 60529		Protection against direct finger contact IP2X		
Protective treatment	Conforming to IEC 60068-2-30		IEC60068-2-30 Test Db, Variant 2		
Ambiant air temperature around the device	Storage	°C	-60...+80		
	Operation		-5...+55		
	Permissible at UC ⁽¹⁾		-20...+70		
Maximum operating altitude	Without derating	m	3000		
Operating positions	Without derating		±30° in relation to normal vertical mounting plane		
Flame resistance	Conforming to IEC 60695-2-11	°C	850		
Shock resistance ⁽²⁾	Conforming to	Contactor open	7 gn	6 gn	
1/2 sinewave = 11 ms	IEC 60068-2-7	Contactor closed	10 gn		
Vibration resistance ⁽²⁾	Conforming to	Contactor open	1.5 gn		
5...300 Hz	IEC 60068-2-6	Contactor closed	3 gn		

(1) Derating see page E-6.

(2) Without change of contact states, in the most unfavorable direction (coil energised at Ue).

Installation Recommendations



Avoid fire, product damage, or power loss with a safe enclosure

Severe conditions such as dust, humidity, high temperature can result in people or equipments exposed to serious risks if suitable protection of the electrical components is not considered.

Spacial CRN steel enclosures is one of our solutions

A complete offer with 39 dimensions from 200 x 200 x 150 mm to 1000 x 800 x 300 mm:

- with plain door, without plain mounting plate
- with plain door and plain mounting plate
- with glazed door, without plain mounting plate
- Degree of protection IP 66
- Compliance with standard IEC 62208
- A wide range of accessories to fit to all your applications

Spacial CRN, suitable for any application

Indoors with harsh and dirty environments like machines, manufacturing plants, and logistic centers.

Specific optional devices re-enforce the protection:

- fans
- filters

LC1E40...E65

LC1E80...E95

7 gn

Easy TeSys Control

Contactors 3-pole For Motor Control

in category AC-3, AC-3e, 6 A to 630 A for AC supply

3-pole Contactors						Rated operational current at 440 V AC-3/ AC-3e	Instantaneous auxiliary contacts		Basic reference, to be completed by adding the control voltage code	Weight (with AC Coil)
Standard power ratings of 3-phase motors 50/60 Hz							A	1		
220 V	380 V	415V	660V	230 V	400 V	440V			500 V	690 V
kW	kW	kW	kW	kW	kW	kW	kW	kW		
Connection by Screw Clamp Terminals										
1.1	2.2	2.2	3	3	3	6	1	0	LC1E0610●●	0.300
1.1	2.2	2.2	3	3	3	6	0	1	LC1E0601●●	0.300
2.2	4	4	4	4	4	9	1	0	LC1E0910●●	0.300
2.2	4	4	4	4	4	9	0	1	LC1E0901●●	0.300
3	5.5	5.5	5.5	5.5	5.5	12	1	0	LC1E1210●●	0.300
3	5.5	5.5	5.5	5.5	5.5	12	0	1	LC1E1201●●	0.300
4	7.5	9	9	9	9	18	1	0	LC1E1810●●	0.300
4	7.5	9	9	9	9	18	0	1	LC1E1801●●	0.300
5.5	11	11	11	11	11	25	1	0	LC1E2510●●	0.360
5.5	11	11	11	11	11	25	0	1	LC1E2501●●	0.360
7.5	15	15	15	15	15	32	1	0	LC1E3210●●	0.450
7.5	15	15	15	15	15	32	0	1	LC1E3201●●	0.450
9	18.5	18.5	18.5	18.5	18.5	38	1	0	LC1E3810●●	0.450
9	18.5	18.5	18.5	18.5	18.5	38	0	1	LC1E3801●●	0.450
11	18.5	22	22	30	30	40	1	1	LC1E40●●	0.980
11	22	22	30	30	30	50	1	1	LC1E50●●	0.980
18.5	30	37	37	37	37	65	1	1	LC1E65●●	0.980
22	37	45	45	45	45	80	1	1	LC1E80●●	1.520
22	45	45	45	45	45	95	1	1	LC1E95●●	1.520
37	55	59	75	80	80	120/96	1	1	LC1E120●●	2.300
45	75	80	90	100	100	160/100	1	1	LC1E160●●	2.300
Connection by Bars										
55	90	100	110	110	110	200/175	0	0	LC1E200●●	4.600
75	132	140	160	160	160	250/190	0	0	LC1E250●●	4.700
90	160	160/185	200	220	220	300/265	0	0	LC1E300●●	8.500
110	200	220/250	257	280	280	400/330	0	0	LC1E400●●	9.100
147	250	280/295	355	335	335	500/400	0	0	LC1E500●●	11.350
185	335	375/400	400	450	450	630/500	0	0	LC1E630●●	18.600



Coil Voltage Code for 3-pole Contactors

		24	48	110	220	230	240	380	415	440
LC1E06-300	50 Hz	B5	E5	F5	M5	-	U5	Q5	N5	R5
	60 Hz	B6	-	F6	M6	-	-	Q6	-	R6
LC1E06-95	50/60Hz	B7	E7	F7	M7	P7	-	Q7	-	-
	DC	BD	-	-	-	-	-	-	-	-
LC1E120-300	50/60Hz	-	-	F7	M7	-	U7	Q7	-	-
LC1E400-630	50/60Hz	-	E7	F7	M7	-	U7	Q7	N7	R7

Note: The availability of specific models and/or coil voltages can change over time as the availability is subject to market demand. Please check your local Schneider Electric website or contact your Regional Sales Office for the actual status.

Separate Components

Auxiliary contact blocks, add-on modules and accessories, see pages A-22 to A-24.

Coil Spare Parts

For maintenance, each coil can be ordered separately, see page A-25 to A-28.

⁽¹⁾ LC1E06 to E65: clip-on mounting on 35 mm \perp rail AM1 DP or screw fixing.
 LC1E80 to E95: clip-on mounting on 35 mm \perp rail AM1DP or 75 mm \perp rail AM1 DL or screw fixing.
 LC1E120 and E160: clip-on mounting on 2 x 35 mm \perp rail AM1 DP or screw fixing.

Easy TeSys Control

Contactors 3-pole For Motor Control

in category AC-3, AC-3e, 6 A to 95 A for DC supply



LC1E06



LC1E65

3-pole Contactors						Rated operational current at 440 V AC-3/ AC-3e	Instantaneous auxiliary contacts		Basic reference, to be completed by adding the control voltage code	Weight (with AC Coil)
Standard power ratings of 3-phase motors 50/60 Hz							A			
220 V	380 V	415V	660V						Fixing ⁽¹⁾	kg
230 V	400 V	440V	500 V	690 V						
kW	kW	kW	kW	kW						
Connection by Screw Clamp Terminals										
1.1	2.2	2.2	3	3	6	1	0	LC1E0610●●	0.483	
1.1	2.2	2.2	3	3	6	0	1	LC1E0601●●	0.483	
2.2	4	4	4	4	9	1	0	LC1E0910●●	0.483	
2.2	4	4	4	4	9	0	1	LC1E0901●●	0.483	
3	5.5	5.5	5.5	5.5	12	1	0	LC1E1210●●	0.483	
3	5.5	5.5	5.5	5.5	12	0	1	LC1E1201●●	0.483	
4	7.5	9	9	9	18	1	0	LC1E1810●●	0.483	
4	7.5	9	9	9	18	0	1	LC1E1801●●	0.483	
5.5	11	11	11	11	25	1	0	LC1E2510●●	0.483	
5.5	11	11	11	11	25	0	1	LC1E2501●●	0.483	
7.5	15	15	15	15	32	1	0	LC1E3210●●	0.550	
7.5	15	15	15	15	32	0	1	LC1E3201●●	0.550	
9	18.5	18.5	18.5	18.5	38	1	0	LC1E3810●●	0.550	
9	18.5	18.5	18.5	18.5	38	0	1	LC1E3801●●	0.550	
11	18.5	22	22	30	40	1	1	LC1E40●●	2.013	
11	22	22	30	30	50	1	1	LC1E50●●	2.023	
18.5	30	37	37	37	65	1	1	LC1E65●●	2.033	
22	37	45	45	45	80	1	1	LC1E80●●	2.390	
22	45	45	45	45	95	1	1	LC1E95●●	2.400	

Coil Voltage Code for 3-pole Contactors

		24	48	110	220	230	240	380	415	440
LC1E06-300	50 Hz	B5	E5	F5	M5	-	U5	Q5	N5	R5
	60 Hz	B6	-	F6	M6	-	-	Q6	-	R6
LC1E06-95	50/60Hz	B7	E7	F7	M7	P7	-	Q7	-	-
	DC	BD	-	-	-	-	-	-	-	-
LC1E120-300	50/60Hz	-	-	F7	M7	-	U7	Q7	-	-
LC1E400-630	50/60Hz	-	E7	F7	M7	-	U7	Q7	N7	R7

Note: The availability of specific models and/or coil voltages can change over time as the availability is subject to market demand. Please check your local Schneider Electric website or contact your Regional Sales Office for the actual status.

Seperate Components

Auxiliary contact blocks, add-on modules and accessories, see pages A-22 to A-24.

- (1) LC1E06 to E65: clip-on mounting on 35 mm \perp rail AM1 DP or screw fixing.
LC1E80 to E95: clip-on mounting on 35 mm \perp rail AM1DP or 75 mm \perp rail AM1 DL or screw fixing.
LC1E120 and E160: clip-on mounting on 2 x 35 mm \perp rail AM1 DP or screw fixing.

Easy TeSys Control

Contactors 4-pole For load control, in category AC-1, 16 A to 125 A for AC supply



LC1E06



LC1E25





LC1E40



LC1E80

4-pole Contactors

Non inductive loads maximum current (θ≤55°C) utilisation category AC-1	number of poles		Basic reference, to be completed by adding the controy voltage code Fixing ⁽¹⁾	weight kg
				
16	4	-	LC1E06004●●	0.34
	2	2	LC1E06008●●	0.34
20	4	-	LC1E09004●●	0.34
	2	2	LC1E09008●●	0.34
25	4	-	LC1E12004●●	0.34
	2	2	LC1E12008●●	0.34
32	4	-	LC1E18004●●	0.34
	2	2	LC1E18008●●	0.34
40	4	-	LC1E25004●●	0.52
	2	2	LC1E25008●●	0.52
45	4	-	LC1E32004●●	0.52
	2	2	LC1E32008●●	0.52
50	4	-	LC1E38004●●	0.52
	2	2	LC1E38008●●	0.52
60	4	-	LC1E40004●●	1.30
	2	2	LC1E40008●●	1.30
80	4	-	LC1E65004●●	1.30
	2	2	LC1E65008●●	1.30
100	4	-	LC1E80004●●	1.60
	2	2	LC1E80008●●	1.60
125	4	-	LC1E95004●●	1.60
	2	2	LC1E95008●●	1.60

Control Voltage Code for 4-pole Contactors

	24	48	110	220	230	240	380	400	415	
LC1E06-95	50/60 Hz	B7	E7	F7	M7	P7	U7	Q7	V7	N7

Note: The availability of specific models and/or coil voltages can change over time as the availability is subject to market demand. Please check your local Schneider Electric website or contact your Regional Sales Office for the actual status.



Seperate Components

Auxiliary contact blocks, add-on modules and accessories, see pages A-22 to A-24.

Coil Spare Parts

For maintenance, each coil can be ordered separately, please check with Schneider Electric.

 rail AM1 DP or screw fixing.

LC1E40 to E95: clip-on mounting on 35 mm  rail AM1DP or 75 mm  rail AM1 DL or screw fixing.

Easy TeSys Control

Contactors - Power wiring accessories

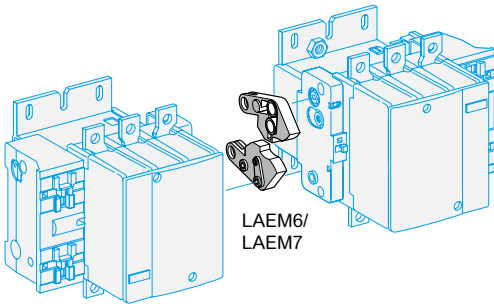
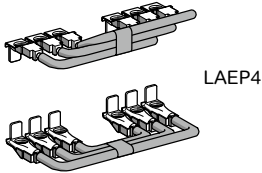
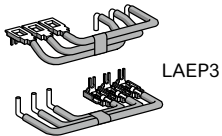
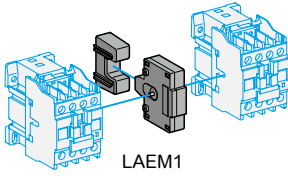

3-pole Accessories for LC1E Contactor with AC supply

Accessories for Motor Reverse Assembly

Contactors with screw clamp terminals				
Using 2 identical contactors	Set of power connections		Mechanical interlock	
	Cat. no.	Weight kg	Cat. no.	Weight kg
Mechanical interlock				
LC1E06...E12	LAEP1	0.020	LAEM1	0.030
LC1E18/E25	LAEP12	0.026	LAEM1	0.030
LC1E32/E38	LAEP2	0.040	LAEM1	0.030
LC1E40...E65	LAEP3	0.230	LAEM1	0.030
LC1E80/E95	LAEP4	0.465	LAEM4	0.095
LC1E120/E160	– (DIY) ⁽¹⁾		LAEM5	0.300
LC1E200/E250	– (DIY) ⁽¹⁾		LAEM6	0.110
LC1E300	– (DIY) ⁽¹⁾		LAEM7	0.250
LC1E400	– (DIY) ⁽¹⁾		LAEM7	0.250
LC1E500	– (DIY) ⁽¹⁾		LAEM7	0.250
LC1E630	– (DIY) ⁽¹⁾		LAEM8	0.270

(1) DIY : Do It Yourself.

3-pole Accessories for LC1E Contactor with DC supply

Accessories for Motor Reverse Assembly

Contactors with screw clamp terminals				
Using 2 identical contactors	mechanical interlock with set of power connection		Mechanical interlock	
	Cat. no.	Weight kg	Cat. no.	Weight kg
Mechanical interlock				
LC1E06...E12	LAD9R1	0.045	LAD9V2	0.005
LC1E18/E25				
LC1E32/E38				
LC1E40/E65	LA9D4002	0.200	LA9D50978	0.100
LC1E80/E95	LA9D8002	0.200	LA9D80978	0.100

4-pole Accessories for LC1E Contactor

Accessories for Motor Reverse Assembly

Contactors with screw clamp terminals		
Using 2 identical contactors	Mechanical interlock	
	Cat. no.	Weight kg
Mechanical interlock		
LC1E06...E12	LAEM1	0.030
LC1E18/E25	LAEM1	0.030
LC1E32/E38	LAEM1	0.030
LC1E40...E65	LAEM4	0.095
LC1E80/E95	LAEM4	0.095

Easy TeSys Control

Contactors - Suppressor modules

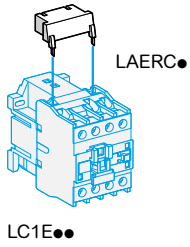

RC circuits (Resistor-Capacitor)

- Effective protection for circuits highly sensitive to high frequency interference and transient generated when the contactor coil is switched off. For use only in cases where the voltage is virtually sinusoidal, i.e. less than 5 % total harmonic distortion.
- Voltage limited to 3 Uc max. and oscillating frequency limited to 400 Hz max.
- Slight increase in drop-out time (1.2 to 2 times the normal time).

Mounting	For use with contactor		Cat. no.	Weight
	Rating	Type		
Screw mounting ⁽¹⁾	LC1E06...E160	V~		kg
		24...48	LAERCE	0.025
		50...127	LAERCG	0.025
		110...240	LAERCU	0.025
		380...415	LAERCN	0.025

Varistors (peak limiting)

- Protection provided by limiting the transient voltage to 2 Uc max.
- Maximum reduction of transient voltage peaks.
- Slight increase in drop-out time (1.1 to 1.5 times the normal time)

Mounting	For use with contactor		Cat. no.	Weight
	Rating	Type		
Screw mounting ⁽¹⁾	LC1E40...E95	V~		kg
		24...48	LA4DE3E	0.018

Flywheel diodes

- No overvoltage or oscillating frequency. Increase in drop-out time (6 to 10 times the normal time).
- Polarised component.

Mounting	For use with contactor		Cat. no.	Weight
	Rating	Type		
Screw mounting ⁽¹⁾	LC1E40...E95	V~		kg
		24...250	LA4DC3U	0.018

Bidirectional peak limiting diodes

- Protection provided by limiting the transient voltage to 2 Uc max.
- Maximum reduction of transient voltage peaks.

Mounting	For use with contactor		Cat. no.	Weight
	Rating	Type		
Screw mounting ⁽¹⁾	LC1E40...E95	V~		kg
		24	LA4DB3B	0.018

⁽¹⁾ Mounting at the top of the contactor on coil terminals A1 and A2.

Easy TeSys Control

Contactors - Auxiliary contact modules



LAEN22



LAETSD

Instantaneous Auxiliary Contact Blocks for Connection by Screw Lamps Terminals

For use in normal operating environment

Clip-on mounting	Number of contacts per block	Cat. no.	Weight kg
Front	1 NO / 1 NC	LAEN11	0.035
	2 NO	LAEN20	0.035
	2 NC	LAEN02	0.035
	2 NO / 2 NC	LAEN22	0.060

Time Delay Auxiliary Contact Blocks for Connection by Screw Clamp Terminals 8 A - 690 V

Clip-on mounting	Number of contacts per block	Time delay Type	Setting range	Cat. no. ⁽¹⁾	Weight kg
Front	1 NO + 1 NC	On-delay	1...30 s	LAETSD	0.060

(1) Not adaptable for LC1E06 to LC1E18 with AC supply

Instantaneous and Time Delay Contact Characteristics

Contact block type			LAEN11, 20, 02, 22			LAETSD		
Number of contacts			2 or 4			2		
Rated operational voltage (Ue)	Up to	V	690					
Rated insulation voltage (Ui)	Conforming to IEC 60947-5-1	V	690					
Conventional thermal current (Ith)	For ambient temperature $\theta \leq 60^\circ\text{C}$	A	10					
Minimum switching capacity	U min	V	17					
		mA	5					
Short-circuit protection	Conforming to IEC 60947-5-1	A	10					
Rated making capacity	Conforming to IEC 60947-5-1	Irms	~ 140					
Short-time rating	Permissible for	A	1 s		100			
			500 ms		120			
			100 ms		140			
Insulation resistance		mΩ	> 10					
Non-overlap time	Guaranteed between NC and NO contacts	ms	1.5 (on energisation and on de-energisation)					
Overlap time	Guaranteed between LAE N22 N/C and N/O contacts	ms	-					
Time delay	Ambient air temperature for operation	°C	-			-20...+70		
	Repeat accuracy		-			±2 %		
	Drift up to 0.5 million operating cycles		-			+15 %		
	Drift depending on ambient air temperature		-			0.25 % per °C		
Mechanical durability		In millions of operating cycles	10			4		
Rated operational power of contacts (Conforming to IEC 60947-5-1)	a.c. supply categories AC14/15	V	24	48	115	230	400	440
	1 million operating cycles	VA	60	120	280	560	960	1050
	3 million operating cycles		16	32	80	160	280	300
	10 million operating cycles		4	8	20	4	70	80

Easy TeSys Control

Contactors - Auxiliary contact modules

Environment				
Contact block type			LAEN11, 20, 02, 22	LAETSD
Conforming to standard			IEC 60947-5-1	
Protective treatment	Conforming to IEC 60068-2-30		IEC60068-2-30 Test Db, Variant 2	
Degree of protection	Conforming to IEC 60529		IP2X	
Ambiant air temperature	Storage	°C	-60...+80	
	Operation		-5...+55	
Maximum operating altitude	Without derating	m	3000	
Connection by cable	Philips N° 2 or Pozidriv N°2 or Ø 6 mm. Flexibility cable with cable end Flexibility cable without cable end Solid Cable	mm ²	Min: 1 x 1 Max: 2 x 2.5	
Tightening torque		N.m	1.2	

3-pole Accessories Compatibility						
Contactor	Built in contacts	LAEN●●	LAETSD	LAERC●	LAEM	LAEP●
LC1E06	1 NO or 1NC	1	-	-	-	-
LC1E09						
LC1E12						
LC1E18						
LC1E25	1 NO + 1NC	1	or 1	1 ⁽²⁾	1	1
LC1E32						
LC1E38						
LC1E40						
LC1E65						
LC1E80	-	2	or 0	-	-	DIY ⁽¹⁾
LC1E95						
LC1E120						
LC1E160						
LC1E200	-	1	or 1	-	-	-
LC1E250						
LC1E300						
LC1E400						
LC1E500						
LC1E630						

(1) Do It Yourself.

4-pole Accessories Compatibility			
Contactor	LAEN●●	LAETSD	LAERC●
LC1E06	1	or 1	1
LC1E09			
LC1E12			
LC1E18			
LC1E25			
LC1E32			
LC1E38			
LC1E40			
LC1E50			
LC1E65			
LC1E80			
LC1E95			

(2) Suppressor LAERC. to be used for contactor with AC supply; for DC supply, suppressor had been embedded.

Easy TeSys Control

Contactors - Spare parts with AC supply

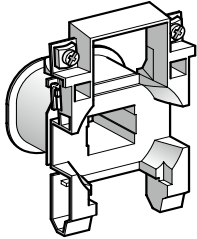

LAEX12●●

For 3-pole Contactors LC1E06...E25

Specifications

Average consumption at 20 °C:

■ inrush (cos φ = 0.75) 50 Hz: 70 VA; 60 Hz: 70 VA

■ sealed (cos φ = 0.3) 50 Hz: 7 VA; 60 Hz: 7.5 VA

Operating range (θ ≤ 55°C): 0.85...1.1 Uc.

Control circuit voltage Uc	Average resistance at 20°C ±10%	Inductance of closed circuit	Cat. no. ⁽¹⁾		Inductance of closed circuit	Cat. no. ⁽¹⁾		Average resistance at 20°C ±10%	Inductance of closed circuit	Cat. no. ⁽¹⁾		Weight
			50 Hz	Ω		60 Hz	Ω			50/60 Hz	kg	
V	Ω	H	50 Hz	Ω	H	60 Hz	Ω	H	50/60 Hz	kg		
24	5.37	0.21	LAEX12B5	5.37	0.18	LAEX12B6	5.2	0.17	LAEX12B7	0.067		
48	21.7	0.84	LAEX12E5	-	-	-	21.0	0.68	LAEX12E7	0.067		
110	124	4.41	LAEX12F5	124	3.68	LAEX12F6	117.1	3.80	LAEX12F7	0.067		
220	515	17.6	LAEX12M5	516	14.7	LAEX12M6	507.5	16.48	LAEX12M7	0.067		
240	562	21.0	LAEX12U5	-	-	-	-	-	-	0.067		
380	1550	52.6	LAEX12Q5	1550	43.8	LAEX12Q6	1397.4	45.38	LAEX12Q7	0.067		
415	1690	62.8	LAEX12N5	-	-	-	-	-	-	0.067		
440	1990	70.6	LAEX12R5	1990	58.9	LAEX12R6	-	-	-	0.067		

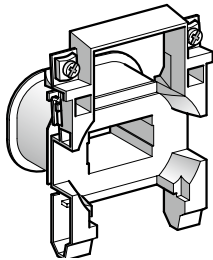

LAEX2●●

For 3-pole Contactors LC1E32/E38

Specifications

Average consumption at 20 °C:

■ inrush (cos φ = 0.75) 50 Hz: 70 VA; 60 Hz: 70 VA

■ sealed (cos φ = 0.3) 50 Hz: 7 VA; 60 Hz: 7.5 VA

Operating range (θ ≤ 55°C): 0.85...1.1 Uc.

Control circuit voltage Uc	Average resistance at 20°C ±10%	Inductance of closed circuit	Cat. no. ⁽¹⁾		Inductance of closed circuit	Cat. no. ⁽¹⁾		Average resistance at 20°C ±10%	Inductance of closed circuit	Cat. no. ⁽¹⁾		Weight
			50 Hz	Ω		60 Hz	Ω			50/60 Hz	kg	
V	Ω	H	50 Hz	Ω	H	60 Hz	Ω	H	50/60 Hz	kg		
24	5.37	0.21	LAEX2B5	5.37	0.18	LAEX2B6	5.2	0.18	LAEX2B7	0.073		
48	21.7	0.84	LAEX2E5	-	-	-	21.1	0.73	LAEX2E7	0.073		
110	124	4.41	LAEX2F5	124	3.68	LAEX2F6	117.0	4.07	LAEX2F7	0.073		
220	515	17.6	LAEX2M5	516	14.7	LAEX2M6	509.7	17.72	LAEX2M7	0.073		
240	562	21.0	LAEX2U5	-	-	-	-	-	-	0.073		
380	1550	52.6	LAEX2Q5	1550	43.8	LAEX2Q6	1536.1	53.40	LAEX2Q7	0.073		
415	1690	62.8	LAEX2N5	-	-	-	-	-	-	0.073		
440	1990	70.6	LAEX2R5	1990	58.9	LAEX2R6	-	-	-	0.073		

(1) The last two digits in the reference represent the voltage code.

Easy TeSys Control

Contactors- Spare parts with AC supply

For 3-pole Contactors LC1E40...E65

Specifications

Average consumption at 20°C:

■ inrush (cos φ = 0.75): 50 Hz: 160 VA; 60 Hz: 140 VA

■ sealed (cos φ = 0.3) 50 Hz: 15 VA; 60 Hz: 13 VA

Operating range (θ ≤ 55°C): 0.85...1.1 Uc

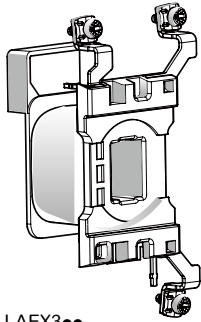

LAEX3●●

Control circuit voltage Uc	Average resistance at 20 °C ±10 %	Inductance of closed circuit	Cat. no. ⁽¹⁾		Average resistance at 20 °C ±10 %	Inductance of closed circuit	Cat. no. ⁽¹⁾		Average resistance at 20 °C ±10 %	Inductance of closed circuit	Cat. no. ⁽¹⁾	Weight
			50 Hz	60 Hz			50/60 Hz					
V	Ω	H	50 Hz	60 Hz	Ω	H	50/60 Hz	50/60 Hz	Ω	H	50/60 Hz	kg
24	1.98	0.12	LAEX3B5	LAEX3B6	1.98	0.10	LAEX3B7	LAEX3B7	1.9	0.11	LAEX3B7	0.110
48	7.97	0.48	LAEX3E5	-	-	-	LAEX3E7	LAEX3E7	7.7	0.43	LAEX3E7	0.110
110	42.3	2.51	LAEX3F5	LAEX3F6	42.3	2.09	LAEX3F7	LAEX3F7	34.4	1.93	LAEX3F7	0.110
220	182	10.0	LAEX3M5	LAEX3M6	182	8.36	LAEX3M7	LAEX3M7	153.9	8.64	LAEX3M7	0.110
240	202	12.0	LAEX3U5	-	-	-	-	-	-	-	-	0.110
380	512	30.3	LAEX3Q5	LAEX3Q6	512	25.3	LAEX3Q7	LAEX3Q7	425.8	23.89	LAEX3Q7	0.110
415	635	35.8	LAEX3N5	-	-	-	-	-	-	-	-	0.110
440	682	40.1	LAEX3R5	LAEX3R6	682	33.4	LAEX3R7	LAEX3R7	-	-	-	0.110

For 3-pole Contactors LC1E80/E95

Specifications

Average consumption at 20°C:

■ inrush (cos φ = 0.75) 50 Hz: 200 VA; 60 Hz: 220 VA

■ sealed (cos φ = 0.3) 50 Hz: 20 VA; 60 Hz: 22 VA

Operating range (θ ≤ 55°C): 0.85...1.1 Uc.

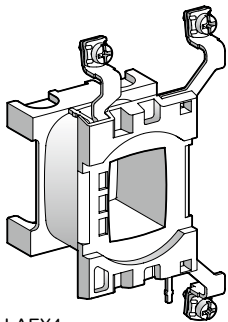

LAEX4●●

Control circuit voltage Uc	Average resistance at 20 °C ±10 %	Inductance of closed circuit	Cat. no. ⁽¹⁾		Average resistance at 20 °C ±10 %	Inductance of closed circuit	Cat. no. ⁽¹⁾		Average resistance at 20 °C ±10 %	Inductance of closed circuit	Cat. no. ⁽¹⁾	Weight
			50 Hz	60 Hz			50/60 Hz					
V	Ω	H	50 Hz	60 Hz	Ω	H	50/60 Hz	50/60 Hz	Ω	H	50/60 Hz	kg
24	1.4	0.09	LAEX4B5	LAEX4B6	1.05	0.04	LAEX4B7	LAEX4B7	1.2	0.09	LAEX4B7	0.145
48	5.5	0.35	LAEX4E5	-	-	-	LAEX4E7	LAEX4E7	4.3	0.36	LAEX4E7	0.145
110	31.0	1.90	LAEX4F5	LAEX4F6	22.0	0.90	LAEX4F7	LAEX4F7	24.0	1.92	LAEX4F7	0.145
220	127	7.50	LAEX4M5	LAEX4M6	98	3.80	LAEX4M7	LAEX4M7	95.0	7.29	LAEX4M7	0.145
240	152	5.4	LAEX4U5	-	-	-	-	-	-	-	-	0.145
380	381	14.11	LAEX4Q5	LAEX4Q6	300	12.17	LAEX4Q7	LAEX4Q7	298.6	23.47	LAEX4Q7	0.145
415	463	16.6	LAEX4N5	-	-	-	-	-	-	-	-	0.145
440	513	18.4	LAEX4R5	LAEX4R6	392	14.3	LAEX4R7	LAEX4R7	-	-	-	0.145

(1) The last two digits in the reference represent the voltage code.

Easy TeSys Control

Contactors - Spare parts with AC supply

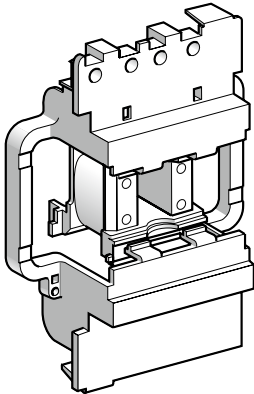

LAEX5●●

For 3-pole Contactors LC1E120/E160

Specifications

Average consumption at 20 °C:

■ inrush (cos φ = 0.8) 50 Hz: 300 VA

■ sealed (cos φ = 0.8) 50 Hz: 22 VA

Operating range (θ ≤ 55°C): 0.85...1.1 Uc.

Control circuit voltage Uc	Average resistance at 20°C ±10%	Inductance of closed circuit	Cat. no. ⁽¹⁾	Average resistance at 20°C ±10%	Inductance of closed circuit	Cat. no. ⁽¹⁾	Weight	Average resistance at 20°C ±10%	Inductance of closed circuit	Cat. no. ⁽¹⁾	Weight
V	Ω	H	50 Hz	Ω	H	60 Hz	kg	Ω	H	50/60 Hz	kg
24	1.24	0.09	LAEX5B5	0.87	0.07	LAEX5B6	0.210	-	-	-	-
48	4.51	0.36	LAEX5E5	-	-	-	-	-	-	-	-
110	26.5	2.00	LAEX5F5	20.0	1.45	LAEX5F6	0.210	4377	109.69	LAEX5F7	0.230
220	105	7.65	LAEX5M5	79.6	5.69	LAEX5M6	0.210	9895	210.72	LAEX5M7	0.230
230	-	-	-	-	-	-	-	-	-	-	-
240	125	8.89	LAEX5U5	-	-	-	0.210	9895	210.72	LAEX5U7	0.230
380	339	22.3	LAEX5Q5	243	17.0	LAEX5Q6	0.210	21011	482.42	LAEX5Q7	0.230
415	368	27.7	LAEX5N5	-	-	-	-	-	-	-	-
440	442	30.3	LAEX5R5	339	22.3	LAEX5R6	0.210	-	-	-	-

⁽¹⁾ The last two digits in the reference represent the voltage code.

Easy TeSys Control

Contactors - Spare parts with AC supply

For 3-pole Contactors LC1E200...E250

Specifications

verage consumption at 20°C:

■ inrush ($\cos \varphi = 0.9$) 50 Hz: 805 VA; 60 Hz: 970 VA

■ sealed ($\cos \varphi = 0.3$) 50 Hz: 55 VA; 60 Hz: 66 VA

Heat dissipation: 18...24 W.

Operating time à Uc: closing = 20...35 ms, opening = 7...15 ms.

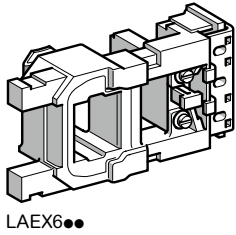

LAEX6●●

Control circuit voltage Uc	Average resistance at 20°C ±10 %	Inductance of closed circuit	Cat. no. (1)		Average resistance at 20°C ±10 %		Inductance of closed circuit		Cat. no. (1)		Weight	
			50 Hz	60 Hz	Ω	H	50/60 Hz	kg				
V	Ω	H	50 Hz	60 Hz	Ω	H	50/60 Hz	kg	Ω	H	50/60 Hz	kg
24	0.18	0.03	LAEX6B5	LAEX6B6	0.13	0.02	/	0.510	/	/	/	/
48	0.71	0.12	LAEX6E5	LAEX6E6	-	-	-	-	-	-	-	-
110	4.2	0.65	LAEX6F5	LAEX6F6	2.7	0.44	LAEX6F7	0.510	411	1.46	LAEX6F7	0.550
220	17	2.59	LAEX6M5	LAEX6M6	11.1	1.80	LAEX6M7	0.510	1680	5.84	LAEX6M7	0.550
230	-	-	-	-	-	-	-	-	-	-	-	-
240	20	3.09	LAEX6U5	LAEX6U6	-	-	LAEX6U7	0.510	2060	7.22	LAEX6U7	0.550
380	51.3	7.8	LAEX6Q5	LAEX6Q6	34	5.3	LAEX6Q7	0.510	4730	16.4	LAEX6Q7	0.550
415	62.3	9.1	LAEX6N5	LAEX6N6	-	-	-	-	-	-	-	-
440	62.3	9.1	LAEX6R5	LAEX6R6	43.5	6.9	LAEX6R7	0.510	-	-	-	-

For 3-pole Contactors LC1E300

Specifications

Average consumption at 20°C:

■ inrush ($\cos \varphi = 0.9$) 50 Hz or 60 Hz: 650 VA

■ sealed ($\cos \varphi = 0.3$) 50 Hz or 60 Hz: 10 VA.

Heat dissipation: 8 W.

Operating time à Uc: closing = 40...65 ms, opening = 100...170 ms.

Operate on networks with harmonic numbers ≤ 7.

Operating cycles/hour ($\theta \leq 55^\circ\text{C}$): ≤ 2400

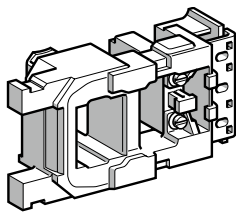

LAEX7●●

Control circuit voltage Uc	Average resistance at 20°C ±10 %	Inductance of closed circuit	Cat. no. (1)		Average resistance at 20°C ±10 %		Inductance of closed circuit		Cat. no. (1)		Weight	
			50 Hz	60 Hz	Ω	H	50/60 Hz	kg				
V	Ω	H	50 Hz	60 Hz	Ω	H	50/60 Hz	kg	Ω	H	50/60 Hz	kg
24	20	(2)	LAEX7B5	LAEX7B6	20	(2)	-	0.770	-	-	-	-
48	67	(2)	LAEX7E5	LAEX7E6	-	-	-	-	-	-	-	-
110	440	(2)	LAEX7F5	LAEX7F6	440	(2)	LAEX7F7	0.770	440	(2)	LAEX7F7	0.770
220	1578	(2)	LAEX7M5	LAEX7M6	1578	(2)	LAEX7M7	0.770	1578	(2)	LAEX7M7	0.770
230	-	-	-	-	-	-	-	-	-	-	-	-
240	1968	(2)	LAEX7U5	LAEX7U6	-	-	LAEX7U7	0.770	1968	(2)	LAEX7U7	0.770
380	4631	(2)	LAEX7Q5	LAEX7Q6	4631	(2)	LAEX7Q7	0.770	4631	(2)	LAEX7Q7	0.770
415	4631	(2)	LAEX7N5	LAEX7N6	-	-	-	-	-	-	-	-
440	6731	(2)	LAEX7R5	LAEX7R6	6730	(2)	LAEX7R7	0.770	-	-	-	-

(1) The last two digits in the reference represent the voltage code.

(2) Please consult your Regional Sales Office.

Easy TeSys Control

Contactors - 3-pole from 6 A to 95 A

Control Circuit : AC

LC1E06...E25

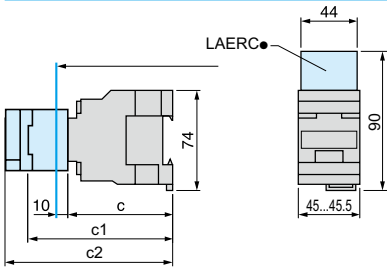

LC1	E06...E18	E25
c	80	85
c1 with LAEN	113	118
c2 with LAETSD	-	136

LC1E32/38

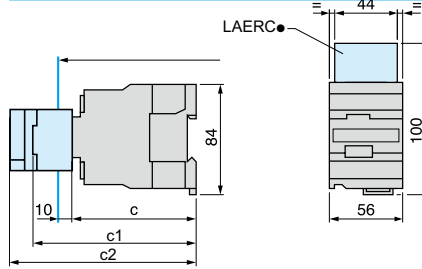

LC1	E32/38
c	86
c1 with LAEN	120
c2 with LAETSD	138

LC1E06...E25

On panel

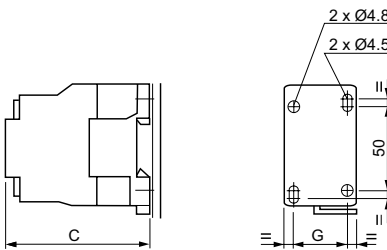

LC1	E06	E09	E12	E18	E25
c	80	80	80	80	85
G	35	35	35	35	35

LC1E32/38

On panel

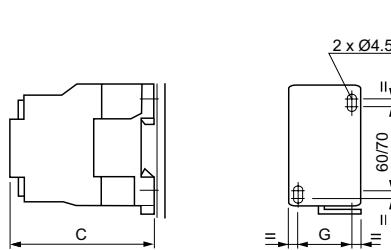

LC1	E32/38
c	86
G	40

LC1E40...E65

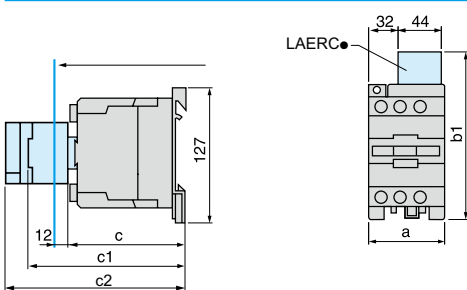

LC1	E40...E65	
a	75	
b1	with LAERC●	135
c		115
c1	with LAEN●	147
c2	with LAETSD	165

LC1E80/95

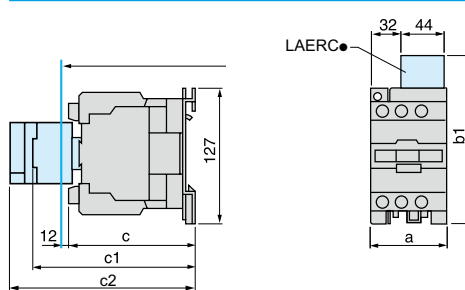

LC1	E80/95	
a	85	
b1	with LAERC●	135
c		124
c1	with LAEN●	153
c2	with LAETSD	171

LC1E40...E65

On panel

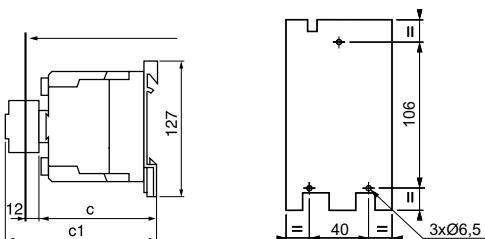

LC1	E40...E65
c	115

LC1E80/95

On panel

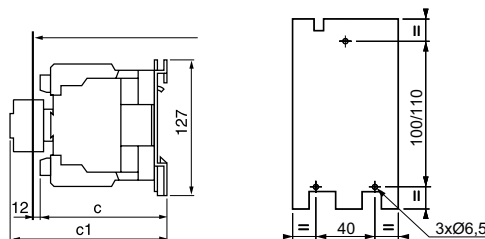

LC1	E80/95
c	124

Easy TeSys Control

Contactors - 3-pole from 6 A to 95 A
Control Circuit : DC

LC1E06...E25

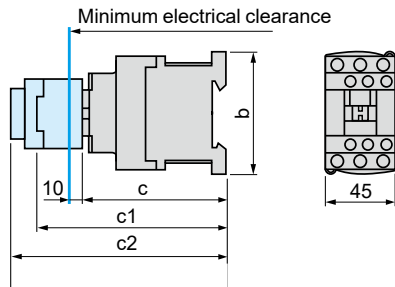

LC1	E06...E25
b	77
c	93
c1 with LAEN (2 or 4 contacts)	126
c2 with LAETSD	146

LC1E32/38

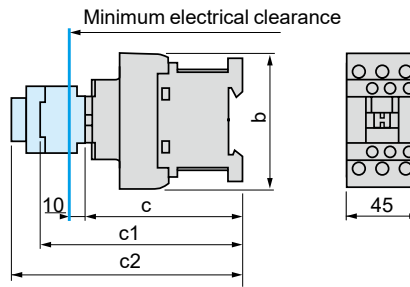

LC1	E32/38
b	85
c	99
c1 with LAEN	132
c2 with LAETSD	152

LC1E06...E38

On panel

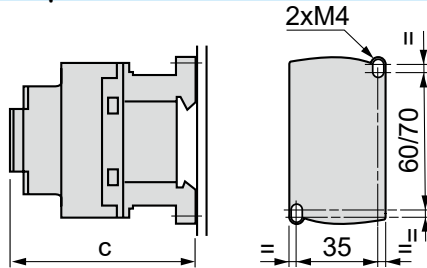

LC1	E06...25	E32/38
c	93	99

LC1E40...95

LC1	E40...65	E80/95
a	75	85
c	171	181
c1	202	221
c2	221	229

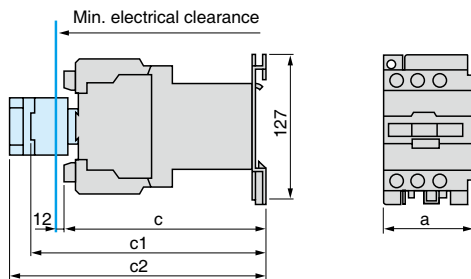

Easy TeSys Control

Contactors - 3-pole from 6 A to 95 A Reversing Contactors

Control Circuit : AC

2 x LC1E06...E65 with LAEM1

2 x LC1E80/95 with LAEM4

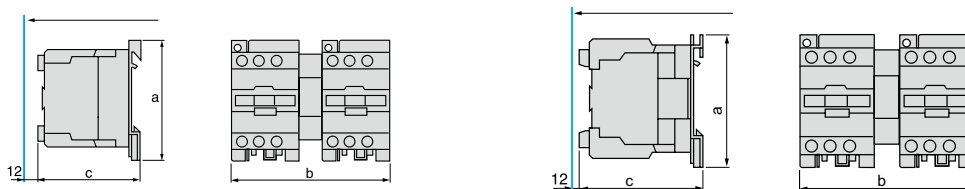

2 x LC1	E06...E25	E32/38	E40/65	E80/95
a	74	84	127	127
b	104	126	164	184
c	80	86	115	121

Control Circuit : DC

2 x LC1E06...E38 with LAD9V2

2 x LC1E40...E95 with LA9D50978

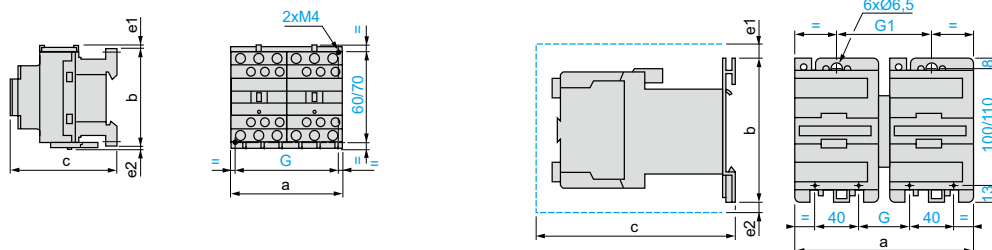

2 x LC1	E06...25	E32/38	E40...65BD	E80/95BD
a	90	90	166	207
b	77	77	127	127
c	93	99	205	215
e1	4	9	13	13
e2	1.5	5	50	58
G	80	80	90	96

e1 and e2: including cabling

Easy TeSys Control

Contactors - 3-pole from 120 A to 160 A
Control Circuit : AC

LC1E120/160

On Panel with Accessories

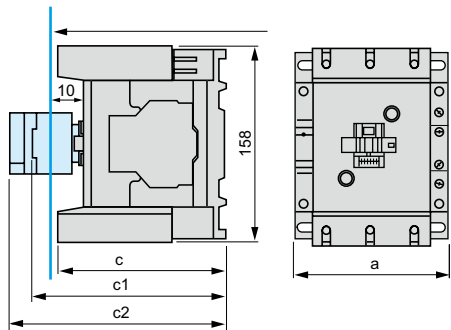

a		120
c	Without add-on blocks	132
c1	With LAEN	150
c2	With LAETSD	168

On 2 mounting rails DZ5 MB on 120 mm centres

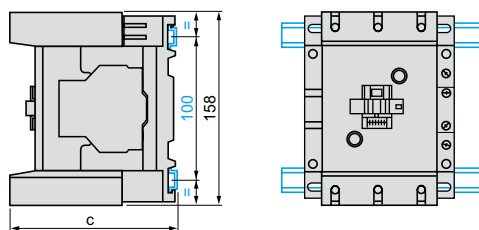

c	(AM1 DP200 or DR200)	134.5
c	(AM1 DE200 or ED●●●)	150

On Panel

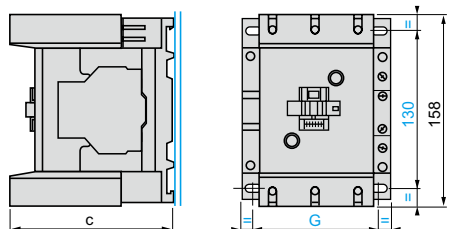

	LC1E120	LC1E160
c	(AM1 DP200 or DR200)	132
G		91/110

2 x LC1E120 or LC160 with LAEM5

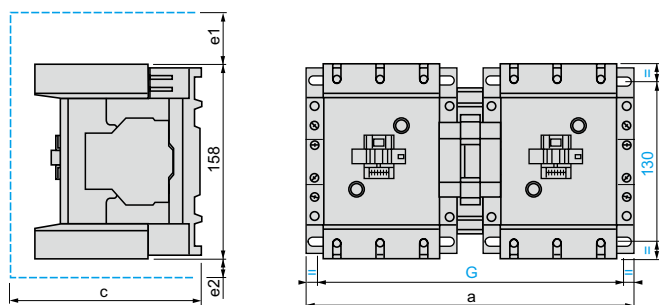

2 x LC1E120 or 160	a	c	e1	e2	G
For 120 and 160	266	148	56	18	242/256

c, e1 and e2: including cabling

Easy TeSys Control

Contactors - 3-pole from 200 A to 300 A Control Circuit : AC

LC1E200 - LC1E250 - LC1E300

On Panel

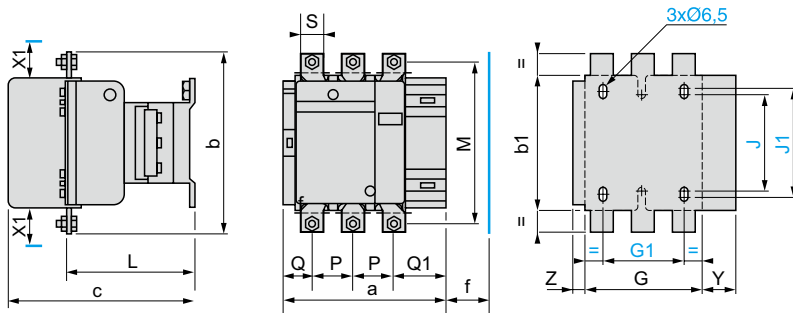

X1 (mm) = minimum electrical clearance according to operating voltage and breaking capacity.

	220...500 V	600...690 V
LC1E200	10	15
LC1E250, 300	10	15

	a	b	b1	c	f	G	G1	J	J1	L	M	P	Q	Q1	S	Y	Z
LC1E200	168.5	174	137	181	130	111	80	106	120	113.5	154	40	29	59.5	20	44	13.5
LC1E250	168.5	197	137	181	130	111	80	106	120	113.5	172	48	21	51.5	25	44	13.5
LC1E300	213	206	145	219	147	154.5	96	106	120	145	181	48	43	74	25	38	20.5

f = minimum distance required for coil removal.

2 x LC1E200 or LC1E250 with LAEM6 - 2 x LC1E300 with LAEM7

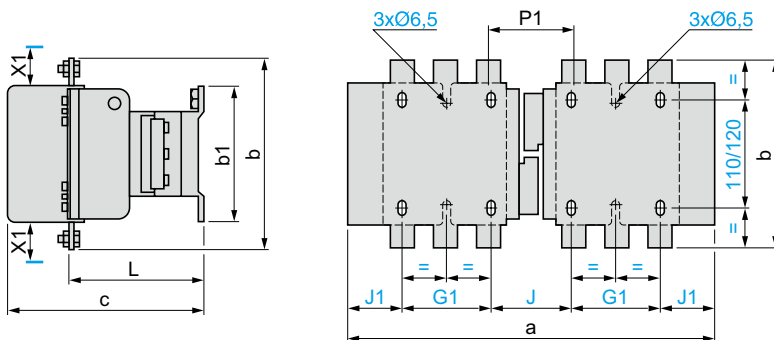

X1 (mm) = minimum electrical clearance according to operating voltage and breaking capacity.

	220...500 V	600...690 V
LC1E200	10	15
LC1E250, 300	10	15

	a	b	b1	c	G1	J	J1	L	P1
2 x LC1E200	357	174	137	181	80	78	59.5	113.5	78
2 x LC1E250	357	197	137	181	80	78	59.5	113.5	62
2 x LC1E300	447	206	145	219	96	124	65.5	145	107

Easy TeSys Control

Contactors - 3-pole from 400 A to 630 A

Control Circuit : AC

LC1E400 - LC1E500

On Panel

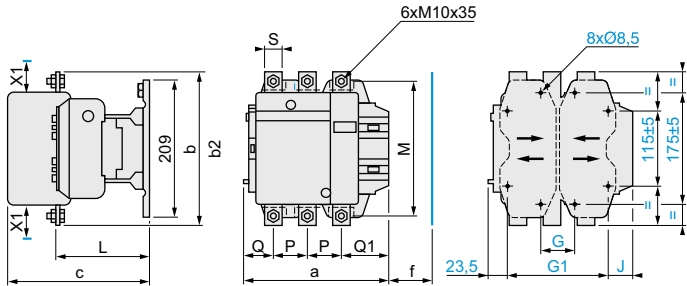

X1 (mm) minimum electrical clearance according to operating voltage and breaking capacity.

	220...500 V	600...690 V
LC1E400	15	20
LC1E500	15	20

	a	b	b2	c	f	G*	Gmin.	Gmax.	G1*	G1min.	G1max.	J	L	M	P	Q	Q1	S
LC1E400	213	206	375	219	146	80	66	102	170	156	192	19.5	145	181	48	43	74	25
LC1E500	233	238	400	232	150	80	66	120	170	156	210	39.5	146	208	55	46	77	30

f = minimum distance required for coil removal

LC1E630

On Panel

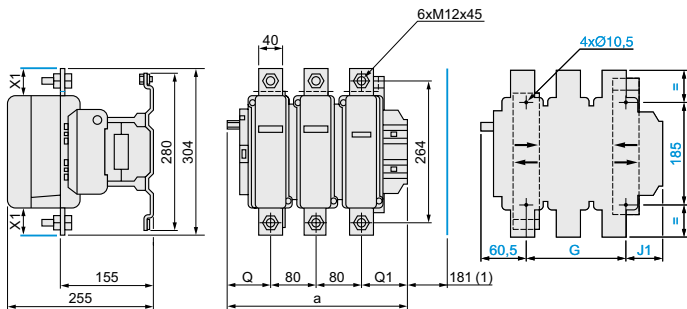

X1 (mm) = minimum electrical clearance according to operation voltage and breaking capacity.

	220...500 V	600...690 V
LC1E630	20	30

(1) Minimum distance required for coil removal.

	a	G*	G min	Gmax.	J1	Q	Q1
LC1E630	309	180	100	195	68.5	60	89

2 x LC1E400, LC1E500, LC1E630

On Panel

X1 (mm) = minimum electrical clearance according to operating voltage and breaking capacity.

	220...500 V	600...690 V
LC1E400,500	15	20
LC1E630	20	30

- (1) Except LC1 E630 : 4 x Ø 10.5.
- (2) Except LC1 E630 : 180±5 mm.

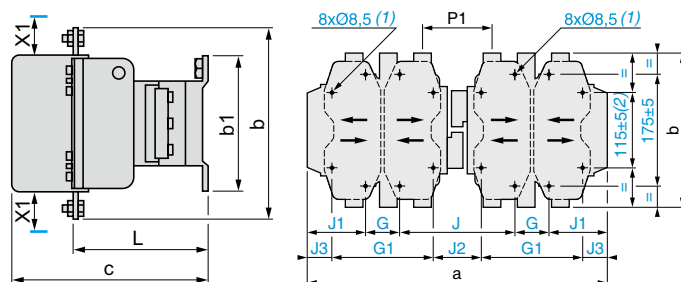

	a	b	b1	c	G	G1	J	J1	J2	J3	L	P1
2 x LC1E400	446	206	209	219	80	170	157	64.5	67	19.5	145	107
3 x LC1E500	485	238	209	232	80	170	156	84.5	66	39.5	146	112
4 x LC1E630	636	304	280	255	180	-	139	68.5	-	-	155	137

Easy TeSys Control

Contactors - 4-pole from 6 A to 95 A

Control Circuit : AC

LC1E06...E18

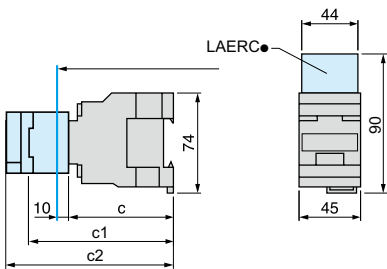

LC1	E06/E18
c	80
c1 with LAEN	113
c2 with LAETSD	135

LC1E25...E38

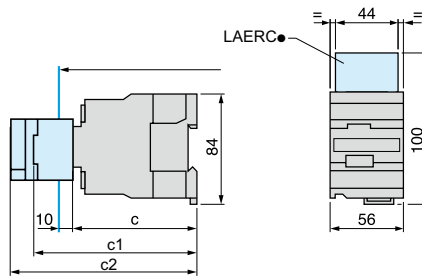

LC1	E25/38
c	93
c1 with LAEN	125
c2 with LAETSD	147

LC1E06...E18

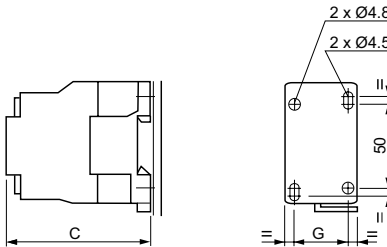

LC1	E06	E09	E12	E18
c	80	80	80	80
G	35	35	35	35

LC1E25...E38

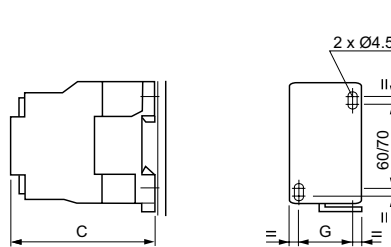

LC1	E25/38
c	93
G	40

LC1E40/65

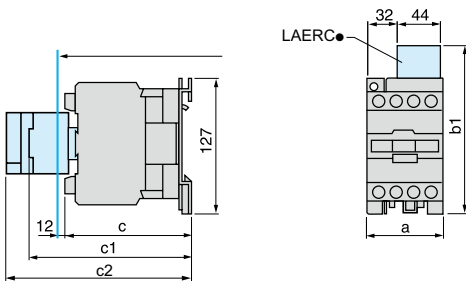

LC1	E40...E65	
a	85	
b1	with LAERC	135
c		110/125
c1	with LAEN	143
c2	with LAETSD	165

LC1E80/95

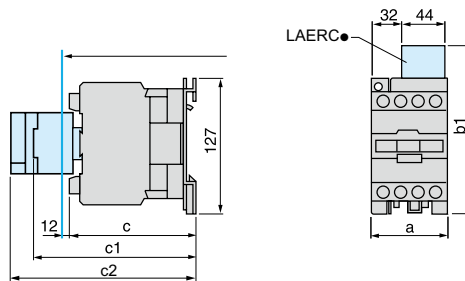

LC1	E80/95	
a	95	
b1	with LAERC	135
c		120/135
c1	with LAEN	160
c2	with LAETSD	172

LC1E40/65

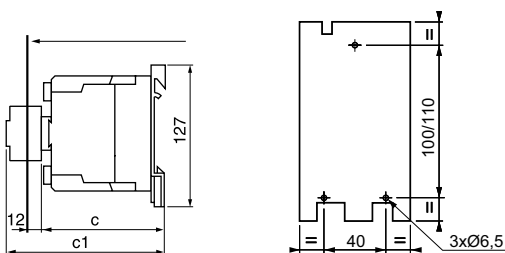

LC1	E40/E65
c	114

LC1E80/95

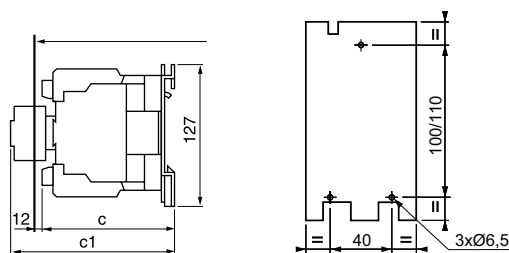

LC1	E80/95
c	121

Easy TeSys Control Contactors

Contactors (3-pole)

LC1E06...38

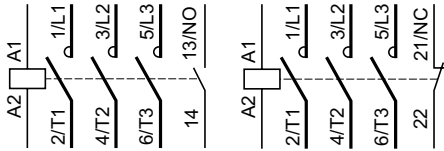

LC1E40...95

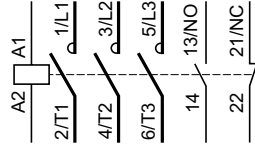

LC1E120/160

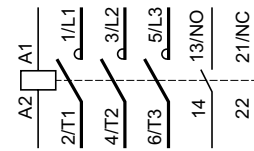

LC1E200, 250, 300

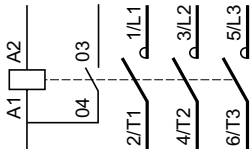

LC1E 400, 500, 630

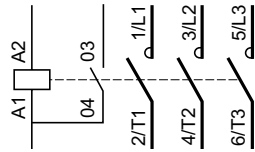

Contactors (4-pole)

LC1E06...95004

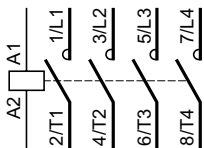

LC1E06...38008

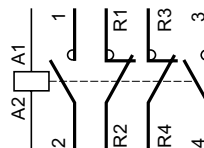

LC1E40...95008

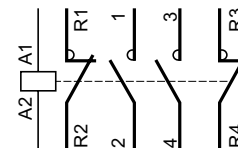

Reversing Contactors

2 x LC1E06...38

2 x LC1E40...95

Horizontally mounted

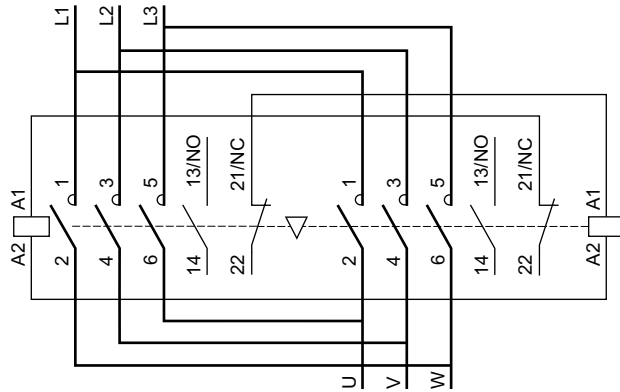
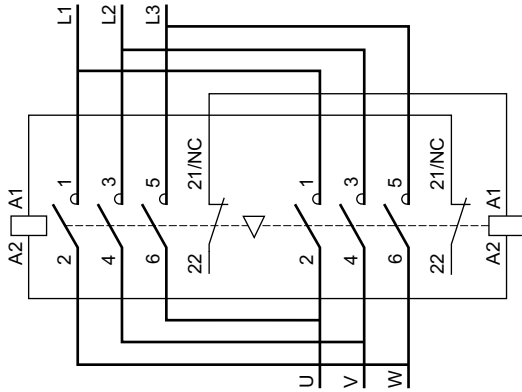

2 x LC1E120, 160

2 x LC1E200, 250, 300

Horizontally mounted

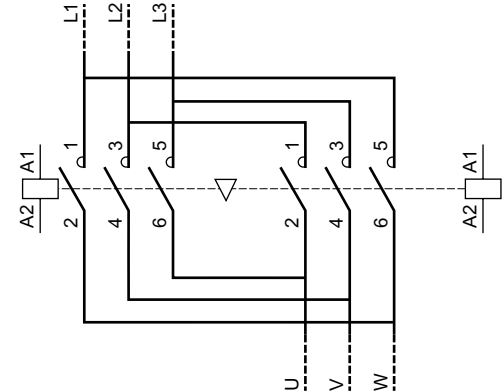
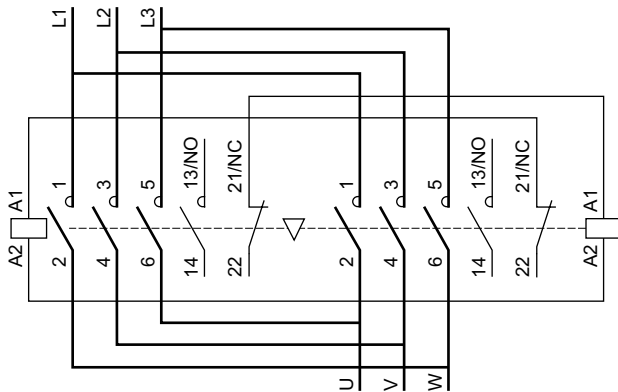

Front Mounting add-on Contact Blocks

1NO + 1NC (LAEN11) 2NO (LAEN20)

2NC (LAEN02)

2NO + 2NC (LAEN22)

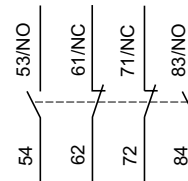
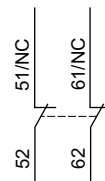
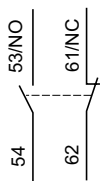

Time Delay Auxiliary Contacts

On delay 1NO + 1NC (LAETSD)

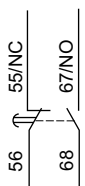

Mechanical Interlock

LAEM●

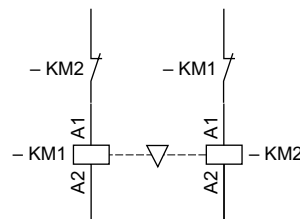

Star-Delta Motor Power Circuit Diagram

Thermal magnetic circuit breaker + contactors

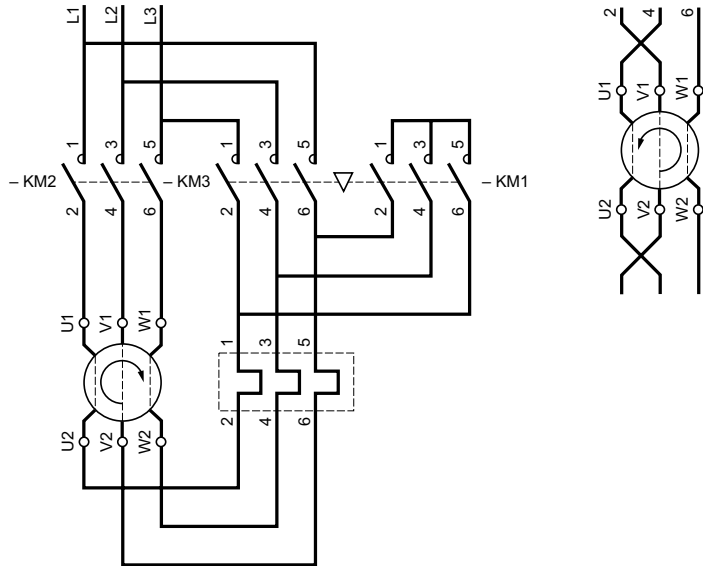

Magnetic circuit breaker + contactors+ overload relay

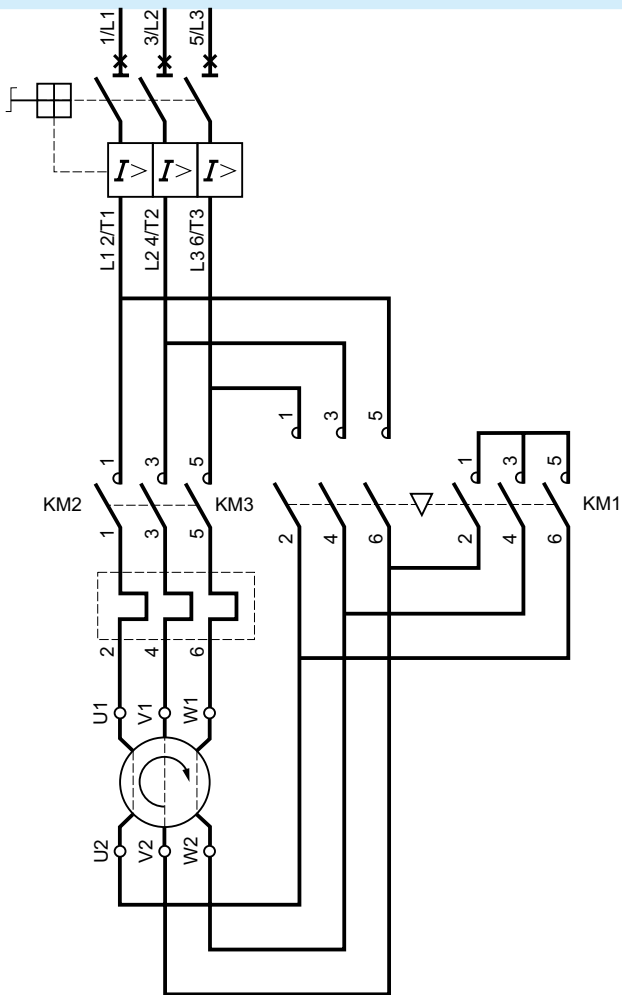

Star-Delta Motor Control Circuit Diagram

LC1E06...95

LC1E120...160

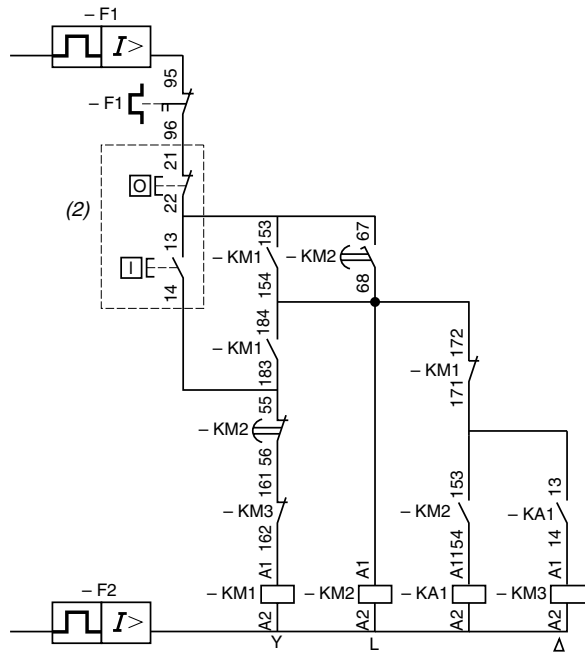
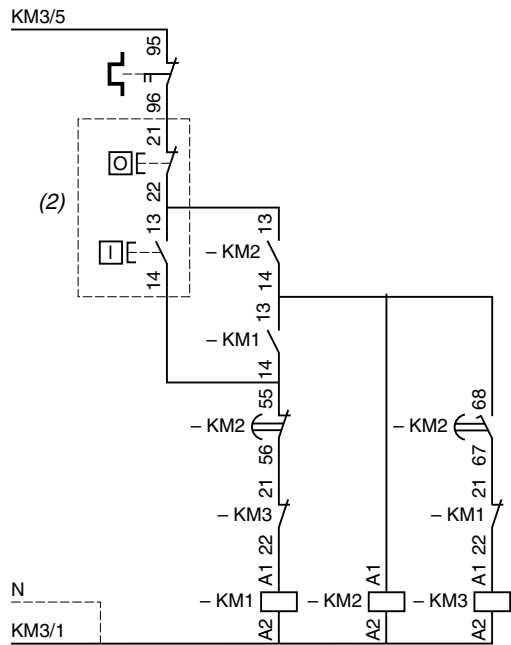

LC1E200...630

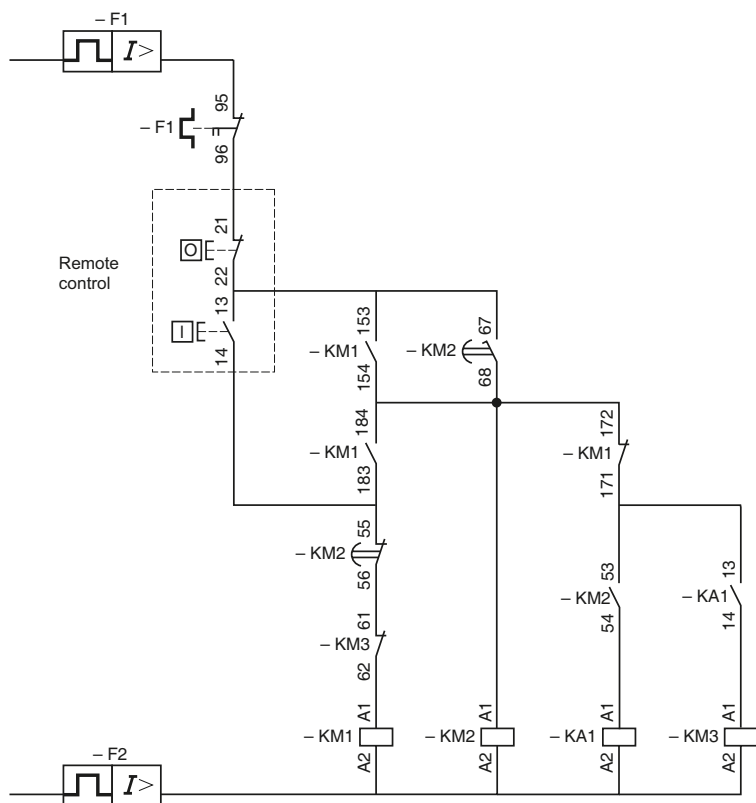

Easy TeSys Control- Control Relays



Contact configuration

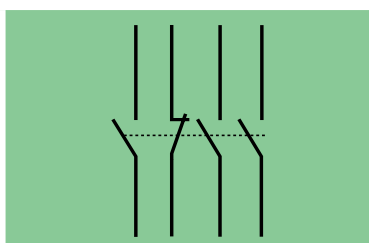
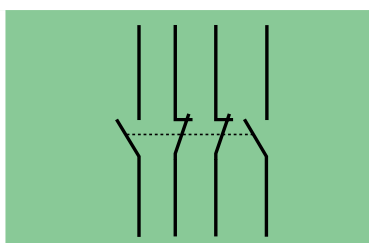
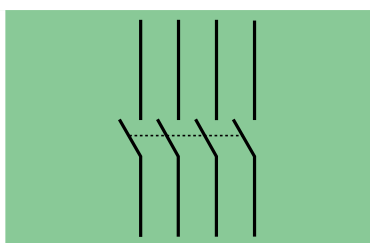

Coil V AC/Hz	50 Hz	50 Hz	50 Hz
24	CAE40B5	CAE22B5	CAE31B5
48	CAE40E5	CAE22E5	CAE31E5
110	CAE40F5	CAE22F5	CAE31F5
220	CAE40M5	CAE22M5	CAE31M5
240	CAE40U5	CAE22U5	CAE31U5
380	CAE40Q5	CAE22Q5	CAE31Q5
415	CAE40N5	CAE22N5	CAE31N5
Coil V AC/Hz	60 Hz	60 Hz	60 Hz
110	CAE40F6	CAE22F6	CAE31F6
220	CAE40M6	CAE22M6	CAE31M6
440	CAE40R6	CAE22R6	CAE31R6

Control Circuit Characteristics				
Type			CAE~	
Rated control circuit voltage (Uc)			V	24...440
Control voltage limits	Operation	Coil type: 50 Hz		0.85...1.1 Uc
	Drop-out			0.3...0.6 Uc
Average consumption at 20°C and at Uc	~ 50 Hz		VA	Sealed and closed: 70 Maintain: 8
Operating time (rated control circuit voltage, ambient temperature 20°C)	Between coil energisation and	opening of the N/C contact	ms	4...19
		closing of the N/O contact		12...22
	Between coil de-energisation and	opening of the N/O contact		4...12
		closing of the N/C contact		6...17
Momentary supply failure	Maximum power-off time without influencing sealed state			2
Maximum operating rate	Operating cycles per second			3
Mechanical durability In millions of operating cycles	Coil type:	50 Hz		10
Control Connection (coil)				
Connecting to screw clamp terminals	Flexible cable without cable end	1 conductor	mm²	1...2.5
		2 conductors		1...2.5
	Flexible cable with cable end	1 conductor		1...2.5
		2 conductors		1...2.5
	Solid cable without cable end	1 conductor		1...2.5
		2 conductors		1...2.5
Tightening torque			N.m	1.2
Characteristics of Built in Instantaneous Contacts				
Number of contacts				4
Rated operational voltage (Ue)	Up to		V	690
Rated insulation voltage (Ui)	Conforming to IEC 60947-5-1			690
Conventional thermal current (Ith)	Operational environment temperature ≤ 40°C		A	10
Operating current frequency			Hz	50
Minimum switching capacity	U min		V	17
	I min		mA	5
Short-circuit protection	Conforming to IEC 60947-5-1		A	gG fuse: 10 A
Rated making capacity	Conforming to IEC 60947-5-1		A	~: 140
Short-time rating	Permissible for	500 ms	A	120
		100 ms		140
Insulation resistance			mΩ	> 10
Non-overlap time	Guaranteed non-overlap between N/C and N/O contacts		ms	1.5 on energisation and on de-energisation
Tightening torque	Phillips n°2 or Pozidriv N°2		N.m	1.2
Non-overlap distance				Contact LAEN●● connecting with auxiliary contacts
Instantaneous Contacts Connection				
Connecting to screw clamp terminals	Flexible cable without cable end	1 conductor	mm²	1...2.5
		2 conductors		1...2.5
	Flexible cable with cable end	1 conductor		1...2.5
		2 conductors		1...2.5
	Solid cable without cable end	1 conductor		1...2.5
		2 conductors		1...2.5
Tightening torque			N.m	1.2

Easy TeSys Control Control Relays

Environment			
Type		CAE	
Rated insulation voltage (Ui)	Conforming to IEC 60947-5-1	V	690
Rated impulse withstand voltage (Uimp)	Conforming to IEC 60947	kV	6
Electrical insulation	IEC 60536		Up to 400 V reinforced insulation
Conforming to standards			IEC 60947-5-1
Certifications			CB Scheme, CE, CCC, EAC
Protective treatment	Conforming to IEC 60068-2-30		IEC60068-2-30 Test Db, Variant 2
Degree of protection	Conforming to IEC 60529		IP2X
Ambient air temperature around the device	Storage	°C	-60...+80
	0.85...1.1 UC		-5...+55
	For operation at Uc		-20...+70
Maximum operating altitude	Without derating	m	3000
Operating position	Without derating in the following positions		
Shock resistance ⁽¹⁾ 1/2 sine wave, 11 ms	Control relay open		7 gn
	Control relay closed		10 gn
Vibration resistance ⁽¹⁾ 5...300 Hz	Control relay open		1.5 gn
	Control relay closed		3 gn
Weight		kg	0.280

(1) No change of contact state at coil voltage Ue in worst conditions.

Rated Operational Power of Contacts (Conforming to IEC 60947-5-1)

a.c. supply. categories AC-14 and AC-15

Electrical durability (valid for up to 3600 operating cycles/hour) on an inductive load such as the coil of an electromagnet:
making current ($\cos \varphi 0.7$) = 10 times the power broken ($\cos \varphi 0.4$).

d.c. supply. categories DC-13

Electrical durability (valid for up to 1200 operating cycles/hour) on an inductive load such as the coil of an electromagnet, without economy resistor, the time constant increasing with the power.

Number of Operation Cycles

AC-14/AC-15	Volts ~	24 VAC	48 VAC	115 VAC	230 VAC	400 VAC	440 VAC	600 VAC
1 million operating cycles	VA	20	39	94	188	327	360	491
3 million operating cycles	VA	9	18	42	84	146	161	219
10 million operating cycles	VA	3	6	13	26	46	51	69

DC-13	Volts ---	24 VDC	48 VDC	125 VDC	250 VDC	400 VDC
1 million operating cycles	W	80	60	50	45	40
3 million operating cycles	W	47	34	25	22	18
10 million operating cycles	W	17	12	10	8	7

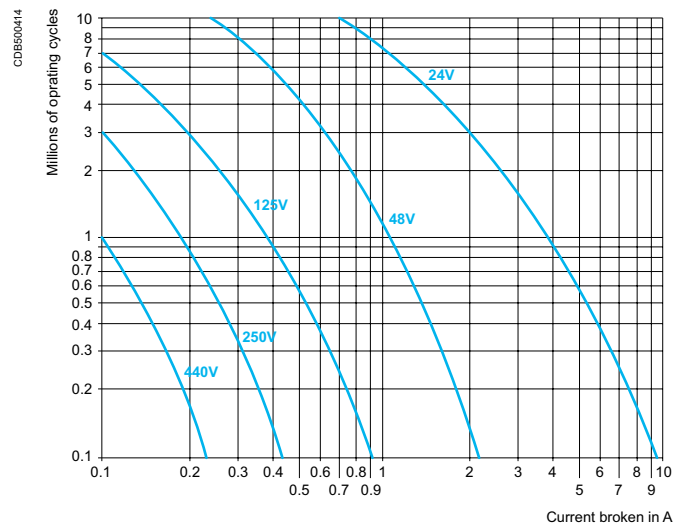
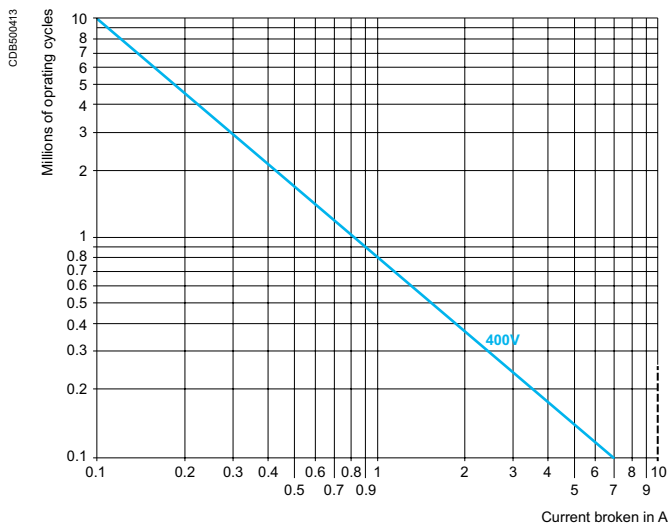

CAE●●

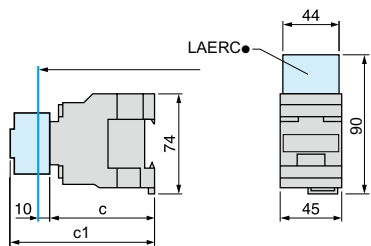

CAE	32	50
c	80	80
c1 with LAEN	113	113

CAE

On mounting plate AM1-P

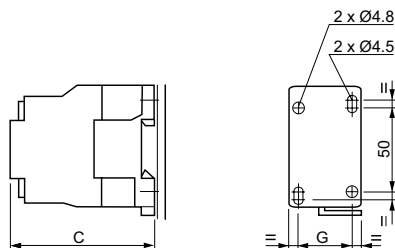

CAE~	
c	80
G	35

CAE40

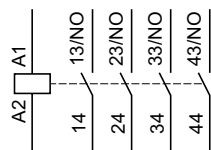

CAE31

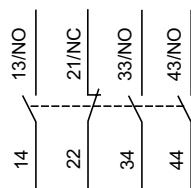

CAE22

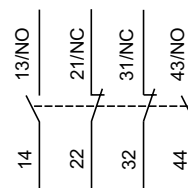

Easy TeSys Control

Control Relays - Auxiliary contact block, RC suppressor

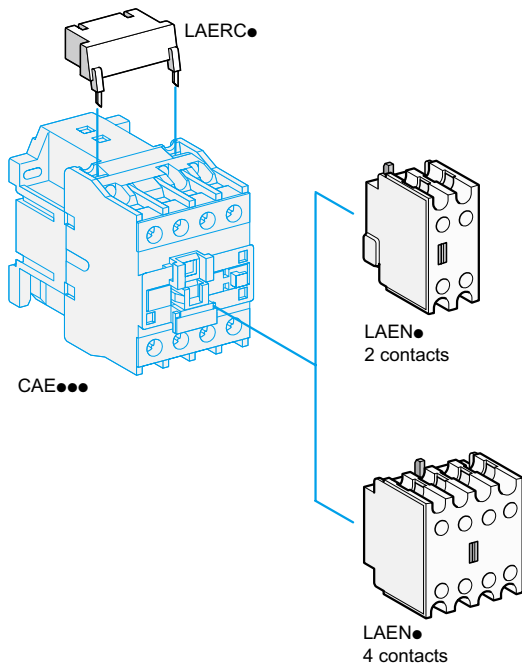

Instantaneous Auxiliary Contact Blocks

For use in normal operating environments ⁽¹⁾

Number of contacts	Maximum number of relays that can be mounted		Composition		Cat. no.	Weight kg
	Front mounted	Side mounted	NO	NC		
2	1	-	1	1	LAEN11	0.030
	1	-	2	-	LAEN20	0.030
	1	-	-	2	LAEN02	0.030
4	1	-	2	2	LAEN22	0.050

⁽¹⁾ For use in particularly harsh industrial environments, please consult the auxiliary contact blocks with dust and damp protected contacts in TeSys catalog.

Coil Suppressor Modules

RC suppressor

- Effective protection for circuits highly sensitive to "high frequency" interference and transient generated when the contactor coil is switched off. For use only in cases where the voltage is virtually sinusoidal, i.e. less than 5 % total harmonic distortion.
- Voltage limited to 3 Uc max. and oscillating frequency limited to 400 Hz max.
- Slight increase in drop-out time (1.2 to 2 times the normal time).

Mounted on	Operational voltage	Cat. no.	Weight kg
CAE40●●	~24...48 V	LAERCE	0.012
	~110...240 V	LAERCU	0.012
	~50...120 V	LAERCG	0.012
	~380...415 V	LAERCN	0.012

Easy TeSys Protect

Thermal Overload Relays



TOR Com. Ref	Possible I _{max} Calibration	Compatible with Contactor (size 1 & 2) Com. Ref.						
		LC1E06	LC1E09	LC1E12	LC1E18	LC1E25	LC1E32	LC1E38
LRE01	0.10...0.16 A	■	■	■	■	■	■	■
LRE02	0.16...0.25 A	■	■	■	■	■	■	■
LRE03	0.25...0.40 A	■	■	■	■	■	■	■
LRE04	0.40...0.63 A	■	■	■	■	■	■	■
LRE05	0.63...1 A	■	■	■	■	■	■	■
LRE06	1...1.6 A	■	■	■	■	■	■	■
LRE07	1.6...2.5 A	■	■	■	■	■	■	■
LRE08	2.5...4 A	■	■	■	■	■	■	■
LRE10	4...6 A	■	■			■	■	■
LRE12	5.5...8 A		■	■	■	■	■	■
LRE14	7...10 A		■	■	■	■	■	■
LRE16	9 ...13 A			■	■	■	■	■
LRE21	12...18 A				■	■	■	■
LRE22	16...24 A					■	■	■
LRE32	23...32 A					■	■	■
LRE35	30...38 A							■

Common characteristics

- > Class: 10 A.
- > Operating voltage: max. 690 V AC.

Accessories

- > LAEB1 Terminal block (see page C-7)
- > LAEB3 Terminal block (see page C-7)
- > LAEB5 Connection Block (see page C-7)

Easy TeSys Protect

Thermal Overload Relays



TOR Com. Ref	Possible I _{max} Calibration	Compatible with Contactor (size 3 & 4) Com. Ref.				
		LC1E40	LC1E50	LC1E65	LC1E80	LC1E95
LRE322	17...25 A	■	■	■	■	■
LRE353	23...32 A	■	■	■	■	■
LRE355	30...40 A	■	■	■	■	■
LRE357	37...50 A		■	■	■	■
LRE359	48...65 A			■	■	■
LRE361	55...70 A				■	■
LRE363	63...80 A				■	■
LRE365	80...104 A					■

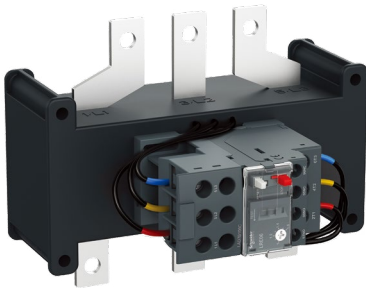

TOR Com. Ref	Possible I _{max} Calibration	Compatible with Contactor (size 5, 6, 7, 8 & 9) Com. Ref.							
		LC1E120	LC1E160	LC1E200	LC1E250	LC1E300	LC1E400	LC1E500	LC1E630
LRE480	51...81A	■	■	□	□	□	□	□	□
LRE481	62...99A	■	■	□	□	□	□	□	□
LRE482	84...135A	■	■	□	□	□	□	□	□
LRE483	124...198A		□	■	□	□	□	□	□
LRE484	146...234A			□	■	■	■	□	□
LRE485	174...279A			□	■	■	■	□	□
LRE486	208...333A				■	■	■	□	□
LRE487	259...414A					■	■	□	□
LRE488	321...513A						□	■	□
LRE489	394...630A							□	■

Note:

- means the relay can match with contactor both in electrical and mechanical.
- means the relay can match with contactor only in electrical (can not directly mounting).

Easy TeSys Protect Thermal Overload Relays

Presentation



Easy Tesys thermal overload relays are designed to protect a.c. circuits and motors against:

- overloads
- phase failure
- Long starting time
- prolonged stalled rotor condition.

The thermal relay controls permanently the current driven by the motor. When this current exceeds the setting it's auxiliary contacts will change state, causing the motor to stop.

Description

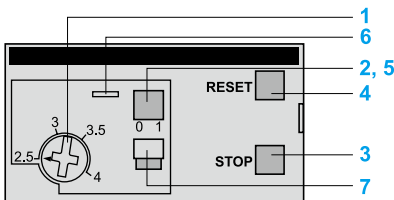

LRE●●, LRE48●

- 1 Adjustment dial I_r.
- 2 Test button.
Operation of the Test button allows:
 - checking of control circuit wiring,
 - simulation of relay tripping (actuates both the N/O and N/C contacts).
- 3 Stop button. Actuates the N/C contact; does not affect the N/O contact.
- 4 Reset button.
- 5 Trip indicator.
- 6 Setting locked by sealing the cover.
- 7 Selector for manual or automatic reset.

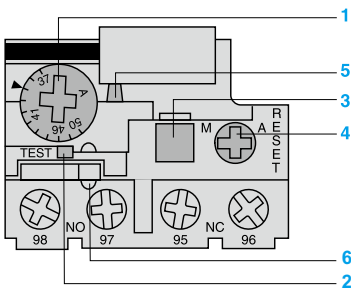

LRE3●●

LRE relays are supplied with the selector in the manual position, protected by a cover. Deliberate action is required to move it to the automatic position.

Power Circuit Characteristics											
Relay type		Ref.	LRE 01...21	LRE 22...35	LRE 322...365	LRE 480...482	LRE 483	LRE 484	LRE 485...487	LRE 488	LRE 489
		Size	1		2		3			4	
Tripping class	Conforming to IEC 60947-4-1		10 A								
Rated insulation voltage	Conforming to IEC 60947-4-1	V	690								
Rated impulse withstand voltage (Uimp)		kV	6								
Frequency limits	Of the operating current	Hz	50...60								
Setting range	Depending on model	A	0.1...18	16...38	17...104	51...630					
Power Circuit Connections											
Connection by screw clamp terminals			Minimum/maximum c.s.a.								
	Flexible cable without cable end 1 conductor	mm ²	1.5...6	2.5...10	4...35	-					
	Flexible cable with cable end 1 conductor		1...4	1.5...6	4...35	-					
	Solid cable without cable end 1 conductor		1...6	2.5...10	4...35	-					
	Tightening torque	N.m	1.7	2.5	9	-					
Connection by bars or lugs											
Pitch	Without spreaders	mm	-			34.8	40	48	48	55	80
Bars or cables with lugs	Cross section		-			3X18	3X20	3X25	4X25	5x30	6X40
Screws	Type		-			M8	M8	M10	M10	M10	M12
	Tightening torque	N.m	-			27.5	27.5	35	35	35	58
Auxiliary Contact Characteristics											
Conventional thermal current		A	5								
Max. sealed consumption of the operating coils of controlled contactors (Occasional operating cycles of contact 95-96)	a.c. supply	V	110	120	220	240	380	480	500	600	
		A	3.27	3	1.63	1.5	0.95	0.75	0.72	0.12	
Protection against short-circuits	By gG, maximum rating or by GB2	A	5								
Connection by screw clamp terminals			Minimum/maximum c.s.a.								
	Flexible cable without cable end 1 conductor	mm ²	2 x 1...2.5								
	Flexible cable with cable end 1 conductor		2 x 1...2.5								
	Solid cable without cable end 1 conductor		2 x 1...2.5								
	Tightening torque	N.m	1.7								
Environment											
Conforming to standard			IEC 60947-4-1, IEC 60947-5-1								
Product certifications			CB Scheme, CE, CCC, EAC								
Degree of protection	Conforming to IEC 60529		IP20				IP00				
Protective treatment	Conforming to IEC 60068-2-30		IEC60068-2-30 Test Db, Variant 2								
Ambiant air temperature	Storage	°C	-60...+80								
	Normal operation without derating (IEC 60947-4-1)		-20...+60								
	Minimum/maximum operating temperature (with derating) ⁽¹⁾		-20...+70								
Operating positions without derating	In relation to normal vertical mounting plane		Any position								
Flame resistance	Conforming to IEC 60068-2-11	°C	850								
Shock resistance	Permissive acceleration conforming to IEC 60068-2-27		6 gn - 11 ms								
Vibration resistance	Permissive acceleration conforming to IEC 60068-2-6		3 gn								
Dielectric strenght at 50 Hz		kV	6								
Impulse withstand voltage			6								
Operating Characteristics											
Temperature compensation		°C	-20...+60								
Tripping threshold	Conforming to IEC 60947-4-1	A	1.14 ± 0.06 I _r								
Sensitivity to phase failure	Conforming to IEC 60947-4-1		Tripping current 130 % of I _r on two phase, the last one at 0								

(1) Contact your regional sales.

Tripping Curves

Average operating time related to multiples of the setting current

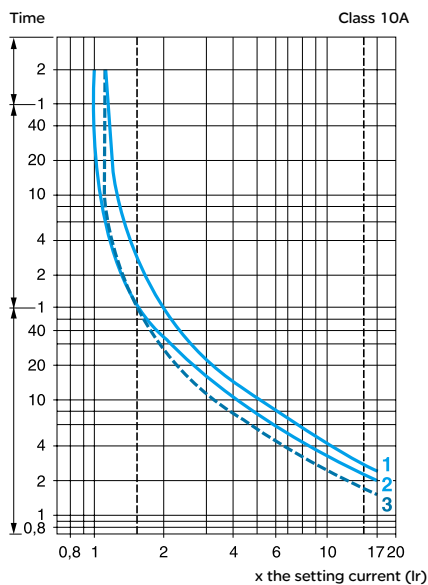

- 1 *Balanced operation, 3-phase, without prior current flow (cold state).*
- 2 *2-phase operation, without prior current flow (cold state).*
- 3 *Balanced operation, 3-phase, after a long period at the set current (hot state).*

Easy TeSys Protect Thermal Overload Relays 3-pole Thermal Overload Relays



LRE01



LRE03

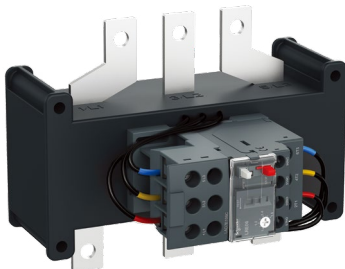

LRE48

Differential Thermal Overload Relays for Use with Fuses or Magnetic Circuit-breakers GV2 L and GV3 L

- Compensated relays with manual or automatic reset,
- with relay trip indicator,
- for a.c.

Relay setting range (A)	Fuses to be used with selected relay		For use with contactor LC1	Reference	Weight kg
	aM (A)	gG (A)			
Class 10 A ⁽¹⁾ for connection by screw clamp terminals					
0.10...0.16	0.25	2	E06...E38	LRE01	0.130
0.16...0.25	0.5	2	E06...E38	LRE02	0.130
0.25...0.40	1	2	E06...E38	LRE03	0.130
0.40...0.63	1	2	E06...E38	LRE04	0.130
0.63...1	2	4	E06...E38	LRE05	0.130
1...1.6	2	4	E06...E38	LRE06	0.130
1.6...2.5	4	6	E06...E38	LRE07	0.130
2.5...4	6	10	E06...E38	LRE08	0.130
4...6	8	16	E06...E38	LRE10	0.130
5.5...8	12	20	E09...E38	LRE12	0.130
7...10	12	20	E09...E38	LRE14	0.130
9...13	16	25	E12...E38	LRE16	0.130
12...18	20	35	E18...E38	LRE21	0.130
16...24	25	50	E25...E38	LRE22	0.130
23...32	40	63	E25...E38	LRE32	0.130
30...38	40	80	E38	LRE35	0.130
17...25	25	50	E40...E95	LRE322	0.470
23...32	40	63	E40...E95	LRE353	0.470
30...40	40	100	E40...E95	LRE355	0.470
37...50	63	100	E50...E95	LRE357	0.460
48...65	63	100	E65...E95	LRE359	0.460
55...70	80	125	E80...E95	LRE361	0.480
63...80	80	125	E80...E95	LRE363	0.480
80...104	80	160	E95	LRE365	0.520
Class 10 A ⁽¹⁾ directly connected by connector					
51...81	100	125	E120...E160	LRE480	2.2
62...99	125	160	E120...E160	LRE481	2.2
84...135	160	200	E120...E160	LRE482	2.2
124...198	200	250	E200	LRE483	2.1
146...234	250	315	E250...E400	LRE484	2.2
174...279	315	315	E250...E400	LRE485	2.2
208...333	400	400	E250...E400	LRE486	2.2
259...414	400	500	E300...E400	LRE487	2.4
321...513	500	800	E500	LRE488	3.2
394...630	630	1000	E630	LRE489	3.9

⁽¹⁾ Standard IEC 60947-4-1 specifies a tripping time for 7.2 times the setting current I_R : class 10 A: between 2 and 10 seconds.

Easy TeSys Protect Thermal Overload Relays

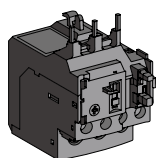
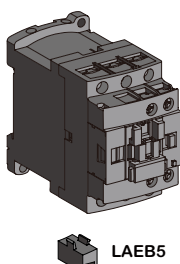
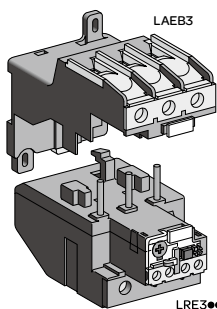
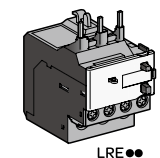
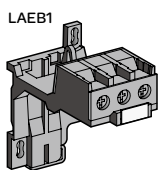

Separate components for relays

Description	For use with	Sold in lots of	Unit reference
Terminal block For clip-on mounting on rail or screwing fixing	LRE01...LRE35	1	LAEB1
	LRE322...LRE365	1	LAEB3
Connection Block allowing direct connection of LRE01-35 to DC contactor	LC1 E06..E25 BD LC1 E32...E38 BD	1	LAEB5

Easy TeSys Protect Thermal Overload Relays Direct Connection to Easy TeSys Contactors

LRE01...E35

Direct mounting under LC1E06...38 contactors with screw clamp connections (Contactor with AC supply)

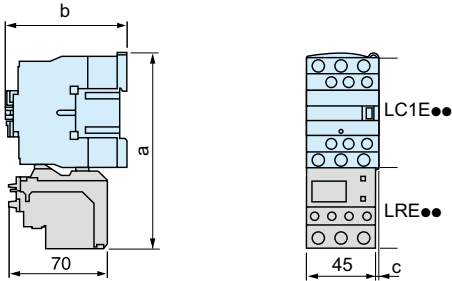

With contactor	LC1E06...E18	LC1E25	LC1E32/E38
a	128	137	137
b	84	92	92
c	0	0	11

LRE01...E35

Direct mounting under LC1E06...38 contactors with LAEB5 and screw clamp connections (Contactor with DC supply)

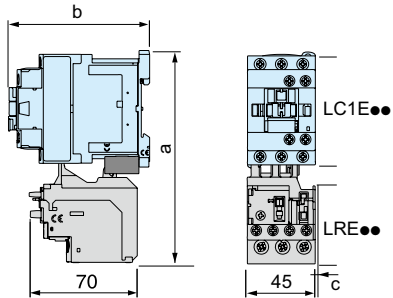

With contactor	LC1E06...E18	LC1E25	LC1E32/E38
a	137	137	151
b	93	93	99
c	2	2	2

LRE3●●

Direct mounting under LC1E40...95 contactors with screw clamp connections

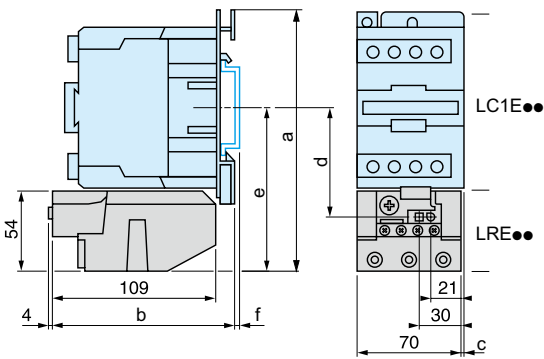

With contactor on DIN rail	AM1-DL201	AM1-DL200			
f	7	17			

Contactor with AC Supply	LC1E40	LC1E50	LC1E65	LC1E80	LC1E95
a	175	175	175	180	180
b	119	119	119	124	124
c	4.5	4.5	4.5	9.5	9.5
d	72.4	72.4	72.4	76.9	76.9
e	111	111	111	115.5	115.5

Contactor with DC supply	LC1E40	LC1E50	LC1E65	LC1E80	LC1E95
a	175	175	175	180	180
b	176	176	176	179.4	179.4
c	4.5	4.5	4.5	9.5	9.5
d	72.4	72.4	72.4	76.9	76.9
e	111	111	111	115.5	115.5

Electrical Diagram all Relays

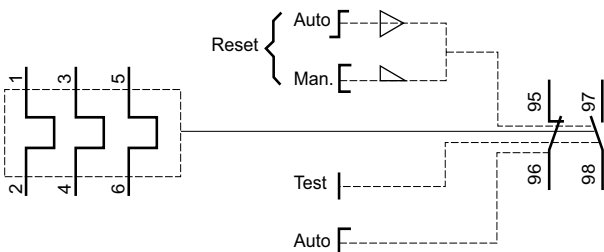

Easy TeSys Protect Thermal Overload Relays Connection to a Terminal Block

LRE01...E35 connected to LAEB1 Terminal Block

Independent mounting on 50 mm centres; or on rail AM1 DP200 or DE200

Independent mounting on 110 mm centres

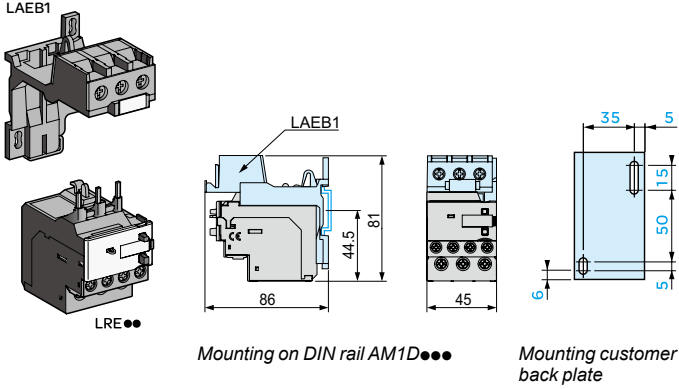

LRE322...E365, Connected to LAEB3 Terminal Block

Independent mounting on 50 mm centres; or on rail AM1 DP200 or DE200

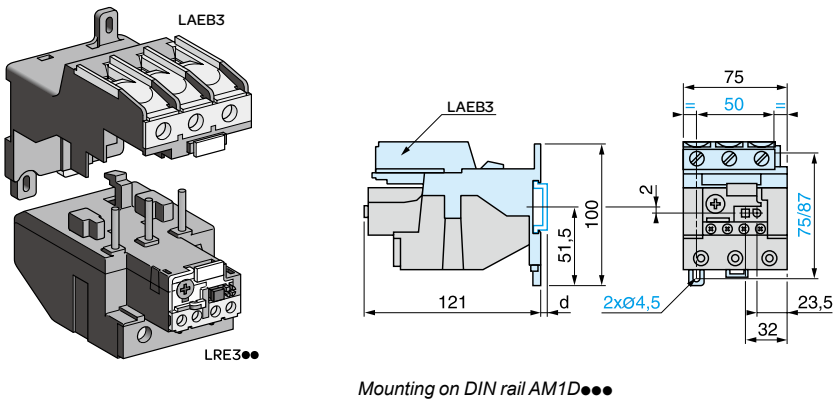

	AM1-DP200	AM1-DE200
d	2	9.5

Easy TeSys Protect

Thermal Overload Relays

Independent Mounting and Connection

LRE48●
Independent Mounting on Mounting Plate

LRE48●: separate mounting (without accessory).

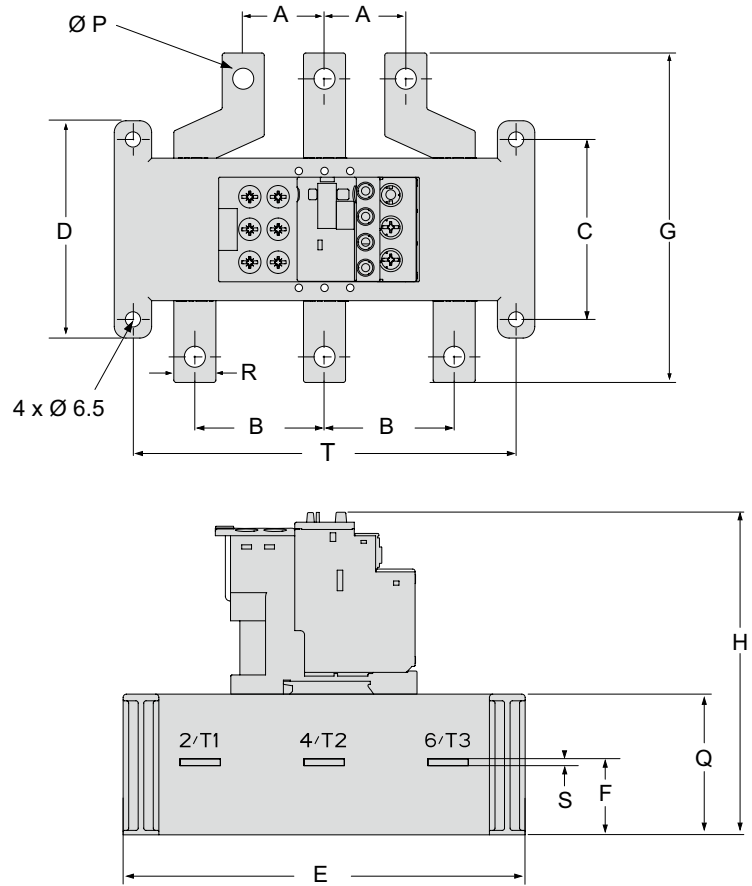

(mm)

Dimensions and Mounting		A	B	C	D	E	F	G	H	P	Q	R	S	T
Range (A)														
LRE480	51...81	34.8	55.5	77	93	180	32	141	142	9	63	18	3	164
LRE481	62...99													
LRE482	84...135													
LRE483	124...198	40	48	77	93	180	32.5	134	142	10	63	20	4	164
LRE484	146...234	25												
LRE485	174...279	25												
LRE486	208...333	55	76	77	93	180	43	140	142	12	63	25	5	164
LRE487	259...414											40		
LRE488	321...513	80	80	77	93	242	43.5	150	156	14	77	30	6	222
LRE489	394...630											40		

Easy TeSys Protect Thermal Overload Relays Independent Mounting and Connection

LRE48●

Independent Mounting on Mounting Plate

LRE48●: with direct mounting under contactors LC1E120...630.

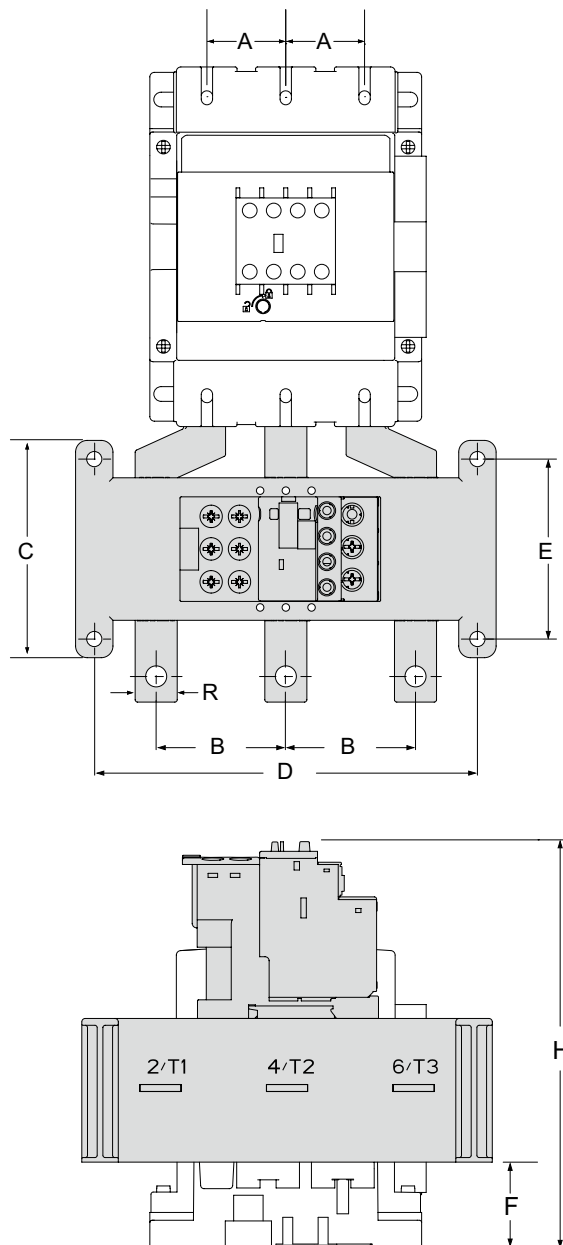

(mm)

Dimensions and Mounting		A	B	C	D	E	F	H		
Range (A)										
LRE480	51...81	34.8	55.5	93	164	77	38	180		
LRE481	62...99									
LRE482	84...135									
LRE483	124...198	40					76	222	82	223
LRE484	146...234									
LRE485	174...279	48					80	125	113	255
LRE486	208...333									
LRE487	259...414	55	80	125	113	264				
LRE488	321...513									
LRE489	394...630	80	80	125	113	279				

Easy TeSys Protect Thermal Overload Relays Independent Mounting and Connection

CDB500412

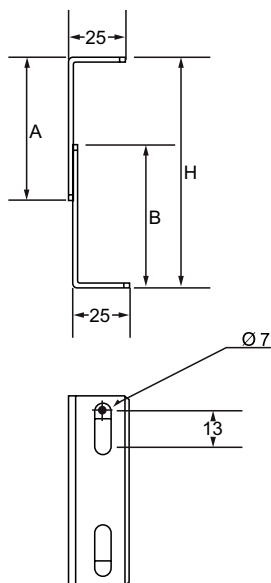
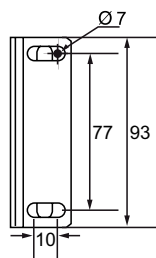
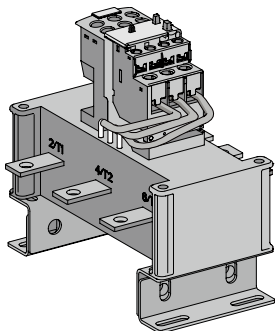

Accessories for LRE48X Thermal Overload Relay			
Relay mounting with Contactor directly			
Relay	Contactor	Mounting support	
		cat No.	weight (Kg)
LRE480	LC1E120...160	LAES1	0.32
LRE481	LC1E120...160	LAES1	0.32
LRE482	LC1E120...160	LAES1	0.32
LRE483	LC1E200	LAES2	0.45
LRE484	LC1E250...300	LAES2	0.45
LRE485	LC1E250...300	LAES2	0.45
LRE486	LC1E250...300	LAES2	0.45

Dimension	LAES1	LAES2	
A (mm)	34	70	
B (mm)	30	70	
H (mm)	34-42	75-90	107-122

What is MPSD?



MPSD (Motor protective switching device) is

Manually operated motor starter additionally providing resettable short-circuit protection to the motor and the circuit.

Conforming to IEC60947-4-1: 2018.

		MPSD (Motor protective switching devices)																
		Thermal-magnetic protection GZ1E	Magnetic-only protection GZ1LE															
	Disconnection and Breaking Conforming to IEC60947-2	● ● ● ● ● ●																
	Short-circuit Protection Conforming to IEC60947-2	● ● ● ● ● ●																
	Overload Protection Conforming to IEC60947-4-1 Rating adjustable overload protection	● ● ● ● ● ● Example: <table border="1"> <thead> <tr> <th>Class</th> <th>1.05xlr</th> <th>1.2xlr</th> <th>1.5xlr</th> <th>7.2xlr</th> </tr> </thead> <tbody> <tr> <td>10A</td> <td>>2hr</td> <td><2hr</td> <td><2min</td> <td>2s - 10s</td> </tr> <tr> <td>10</td> <td>>2hr</td> <td><2hr</td> <td><4min</td> <td>4s - 10s</td> </tr> </tbody> </table>	Class	1.05xlr	1.2xlr	1.5xlr	7.2xlr	10A	>2hr	<2hr	<2min	2s - 10s	10	>2hr	<2hr	<4min	4s - 10s	NO (*)
Class	1.05xlr	1.2xlr	1.5xlr	7.2xlr														
10A	>2hr	<2hr	<2min	2s - 10s														
10	>2hr	<2hr	<4min	4s - 10s														
	Control Conforming to IEC60947-4-1 Manual control Adpated electrical durability for AC3 duty	● ● ● ● ● ●																
	Coordination Capability	● ● ● ● ● ●																

* A separate overload protection is necessary.



MPSD

is the well adapted device to protect your motors with an additional benifit of width saving !

Basic Architecture for Your Motor Management



		Contactors		Soft Starters		Drives	
		Direct-on-Line & Star Delta					
Motor Starter	Power Short Circuit Protection	Easy TeSys MPSD GZ1E	Easy TeSys Magnetic-only MPSD GZ1LE		Easy TeSys MPSD GZ1E	Easy TeSys Magnetic-only MPSD GZ1LE	
	Protect Thermal Protection		Easy TeSys TOR LRE			Altivar Altistart 22	
	Control Motor Control	Easy TeSys Contactors LC1E	Easy TeSys Contactors LC1E		Altivar Altistart 01	VSD ATV 310	

DOL preferred

Diagram Illustration

9 Motor protective switching device (MPSD)
1 Circuit breaker according to IEC60947-2
2 Contactor
3 Overload relay

Offer Illustration

Easy TeSys Power

Motor Circuit Breakers - up to 15 kW

Circuit Breakers for Motor Protection and Control

Easy Tesys motor circuit breakers GZ1 provide easy and essential solutions for:

- Isolation
- Protection against short circuits and overloads
- On-off manual control of motors up to 15kW

They are conforming to, depending of the versions, IEC 60947-2 and IEC 60947-4-1.

Easy Tesys Protection Technologies

Motor circuit breakers GZ1 are carried with 2 variants:

- Thermal-magnetic: GZ1E for protection against short-circuit, overload, phase loss and phase unbalance.
- Magnetic detection: GZ1LE for protection against short-circuit.

With a magnetic circuit breaker, a thermal relay is frequently associated in order to have a short circuit protection and an overload protection.

GZ1 Range Overview

Molded case circuit breakers for motor protection and control.



GZ1LE



GZ1E

GZ1	Protection against		Range	Control	Terminals	Dimensions (W x H x D)
	Short-circuits	Overload				
GZ1LE	●		up to 15kW	Push button	Screw clamp	44.5 x 89 x 66
GZ1E	●	●	up to 15kW	Push button	Screw clamp	44.5 x 89 x 66

Easy TeSys Power Motor Circuit Breakers



GZ1LE

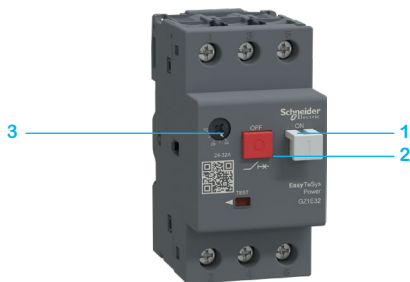

GZ1E

Presentation

Connection

These circuit-breakers are designed for connection by screw clamp terminals. This technique ensures secure, permanent and durable clamping that is resistant to harsh environments, vibration and impact and is even more effective when conductors without cable ends are used. Each connection can take two independent conductors.

Motor ON/OFF pushbutton control

Energisation is controlled manually by operating the Start button "I" **1**. De-energisation is controlled manually by operating the Stop button "O" **2**, or automatically by the thermal-magnetic protection elements or by a voltage trip attachment.

Protection of motors and personnel

For thermal magnetic circuit breakers GZ1E, Motor protection is provided by the thermal-magnetic protection elements incorporated in the motor circuit-breaker. The magnetic elements (short-circuit protection) have a non-adjustable tripping threshold, which is equal to about 13 times the maximum setting current of the thermal trips.

The thermal elements (overload protection) include automatic compensation for ambient temperature variations.

The rated operational current of the motor is displayed by means of a graduated knob **3**.

For magnetic circuit breakers GZ1LE, motor protection is provided by the magnetic protection elements incorporated in the motor circuit breaker. Personnel protection is also provided. All live parts are protected against direct finger contact.

GZ1 E motor circuit-breakers are easily installed in any configuration thanks to their universal fixing arrangement: screw fixing or clip-on mounting on symmetrical, asymmetrical or combination rails.



Motor circuit breakers versus fuse protection?

Circuit breakers are a common solution for protecting motor against short circuits and overloads. As a comparison, a fuse based solution can only provide a partial protection depending on the choice of the fuse type and rating. The thermal magnetic circuit breaker is adjustable and can be fine-tuned to the practical motor load. The fuse based solution offers a very fast protection.

Environment			
Circuit-breaker type		GZ1	
Conforming to standards		IEC 60947-2, IEC 60947-4	
Protective treatment	Conforming to IEC 60068-2-30	IEC60068-2-30 Test Db, Variant 2	
Degree of protection		In GV2 MC01 enclosure: IP 41 In GV2 MC02 enclosure: IP 55	
Ambient air temperature	Storage	°C	-40...+80
	Operation		-20...+60
Flame resistance	Conforming to IEC 60695-2-11	°C	960
Maximum operating altitude		m	2000
Cabling		Min.	Max.
Number of conductors and c.s.a.	Solid cable	mm ²	2 x 1 2 x 6
	Flexible cable without cable end	mm ²	2 x 1.5 2 x 6
	Flexible cable with cable end	mm ²	2 x 1 2 x 4
Suitable for isolation	Conforming to IEC 60947-1 § 7-1-6		Yes
Tightening torque		N.m	1.7
Rated operational voltage (U_e)	Conforming to IEC 60947-2	V	690
Rated insulation voltage (U_i)	Conforming to IEC 60947-2	V	690
Rated operational frequency	Conforming to IEC 60947-2	Hz	50/60
Rated impulse withstand voltage (U_{imp})	Conforming to IEC 60947-2	kV	6
Total power dissipated per pole		W	2.5
Mechanical durability (C.O.: closing, opening)		C.O.	100 000
Electrical durability	For AC-3 duty	C.O.	100 000
Duty class (maximum operating rate)		C.O./h	25

Breaking Capacity			GZ1									
			Circuit-breaker type		01 to 06	07	08	10	14	16	20	21
Rating		A	0.1 to 1.6	2,5	4	6.3	10	14	16	20	23	25 to 32
Breaking capacity conforming to IEC 60947-2	230/240 V	Icu	kA	★	★	★	★	★	★	★	30	30
		Ics % ⁽¹⁾		★	★	★	★	★	★	★	100	100
	400/415 V	Icu	kA	★	★	★	★	★	10	10	10	10
		Ics % ⁽¹⁾		★	★	★	★	★	50	50	40	40
	440 V	Icu	kA	★	★	★	30	10	6	6	5	5
		Ics % ⁽¹⁾		★	★	★	100	100	50	50	50	50
	500 V	Icu	kA	★	★	★	30	8	5	5	3	3
		Ics % ⁽¹⁾		★	★	★	100	100	75	75	75	75
	690 V	Icu	kA	★	2	2	2	2	2	2	2	2
		Ics % ⁽¹⁾		★	75	75	75	75	75	75	75	75

★ > 100 kA.
(1) As % of Icu.

Tripping Curves

Average operating times at 20 °C related to multiples of the setting current

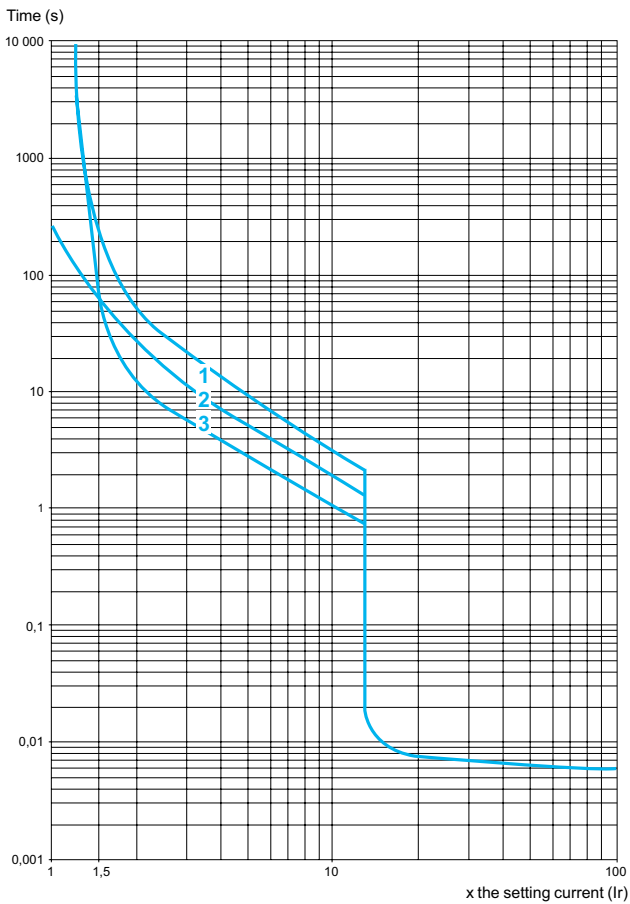

- 1 3 poles from cold state
- 2 2 poles from cold state
- 3 3 poles from hot state

Easy TeSys Power

Motor Circuit Breakers - Magnetic only



GZ1LE

Motor Circuit-breakers										
Pushbutton control										
Standard power ratings of 3-phase motors 50/60 Hz in category AC-3/AC-3e					Magnetic protection rating	Magnetic tripping current $I_d \pm 20\%$	Use in association with thermal overload relays	Reference	Weight	
230V	400V	440V	500V	690V	A	A	(Class 10A)			kg
-	-	-	-	-	0.40	5.8	LRE03	GZ1LE03	0.250	
-	-	-	-	0.37	0.63	9.3	LRE04	GZ1LE04	0.250	
-	-	-	0.37	0.55	1	15.1	LRE05	GZ1LE05	0.250	
-	0.37	0.55	0.75	1.1	1.6	26.2	LRE06	GZ1LE06	0.250	
0.37	0.75	1.1	1.1	1.5	2.5	39	LRE07	GZ1LE07	0.250	
0.75	1.5	1.5	2.2	3	4	74	LRE08	GZ1LE08	0.250	
1.1	2.2	3	3.7	4	6.3	91	LRE10	GZ1LE10	0.250	
2.2	4	4	5.5	7.5	10	149	LRE14	GZ1LE14	0.250	
-	5.5	5.5	9	11	14	253.4	LRE16	GZ1LE16	0.250	
4	7.5	9	10	15	18	341	LRE21	GZ1LE20	0.250	
5.5	11	11	15	22	25	388.3	LRE22	GZ1LE22	0.250	
7.5	15	15	18.5	22	32	538	LRE32	GZ1LE32	0.250	

Easy TeSys Power

Motor Circuit Breakers - Thermal-magnetic



GZ1E

Motor Circuit-breakers								
Pushbutton control								
Standard power ratings of 3-phase motors 50/60 Hz in category AC-3/AC-3e					Setting range of thermal trips	Magnetic tripping current $I_d \pm 20\%$	Reference	Weight
230V	400V	440V	500V	690V	A	A		kg
–	–	–	–	–	0.1...0.16	1.9	GZ1E01	0.260
–	–	–	–	–	0.16...0.25	3.1	GZ1E02	0.260
–	–	–	–	–	0.25...0.40	5.8	GZ1E03	0.260
–	–	–	–	0.37	0.40...0.63	9.3	GZ1E04	0.260
–	–	–	0.37	0.55	0.63...1	15.1	GZ1E05	0.260
–	0.37	0.55	0.75	1.1	1...1.6	26.2	GZ1E06	0.260
0.37	0.75	1.1	1.1	1.5	1.6...2.5	39	GZ1E07	0.260
0.75	1.5	1.5	2.2	3	2.5...4	74	GZ1E08	0.260
1.1	2.2	3	3.7	4	4...6.3	91	GZ1E10	0.260
2.2	4	4	5.5	7.5	6...10	149	GZ1E14	0.260
–	5.5	5.5	9	11	9...14	253.4	GZ1E16	0.260
4	7.5	9	10	15	13...18	341	GZ1E20	0.260
5.5	9	11	11	18.5	17...23	341	GZ1E21	0.260
5.5	11	11	15	22	20...25	388.3	GZ1E22	0.260
7.5	15	15	18.5	22	24...32	538	GZ1E32	0.260

Easy TeSys Power

Motor Circuit Breakers

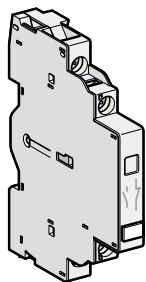

GZ1 AN11

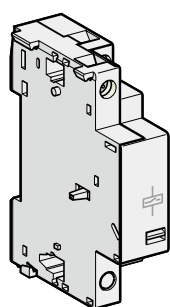

GZ1 AS115

Contact Blocks

Instantaneous auxiliary contacts

Mounting	Maximum number	Type of contacts	Sold in lots of	Unit reference	Weight kg	Tightening torque
Side	2	N/O + N/C	1	GZ1AN11	0.050	1.2
LH side		N/O + N/O	1	GZ1AN20	0.050	1.2

Electric Trips

Montage	Type	Tension		Reference	Weight kg	Tightening torque
Side (1 block on RH side of circuit- breaker)	Undervoltage trip	110...115 V	50 Hz	GZ1AU115	0.105	1.2
		220...240 V	50 Hz	GZ1AU225	0.105	1.2
		380...400 V	50 Hz	GZ1AU385	0.105	1.2
	Shunt trip	110...115 V	50 Hz	GZ1AS115	0.105	1.2
		220...240 V	50 Hz	GZ1AS225	0.105	1.2

Mounting Accessory

Description	Application	Sold in lots of	Unit reference	Weight kg
Adapter plate	For screw fixing of a GZ1	10	GV2AF02	0.021

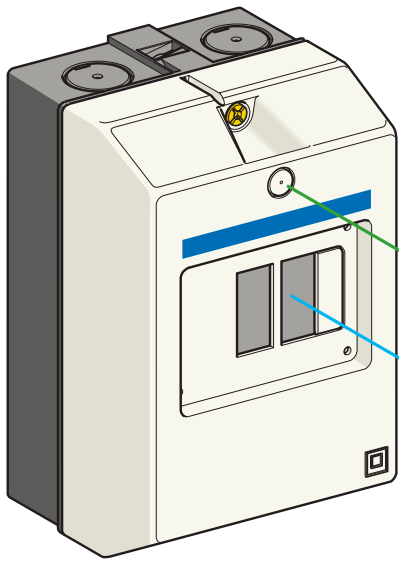

GV2 MC

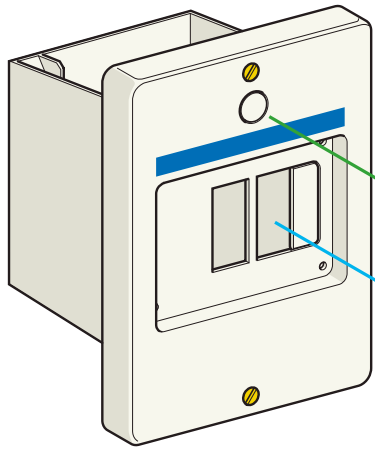

GV2 MP

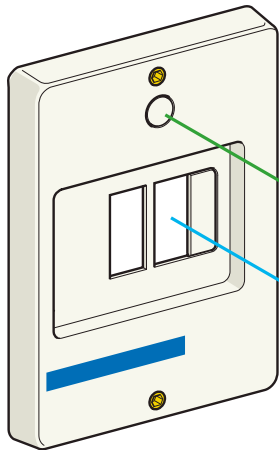

GV2 CP

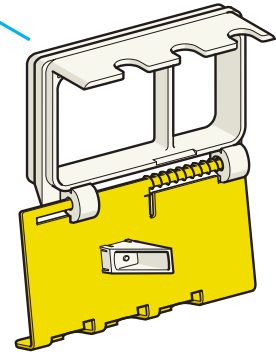
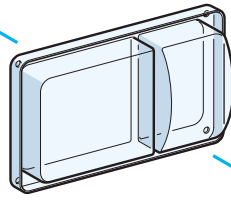

GV2 V01

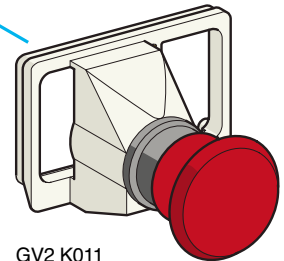
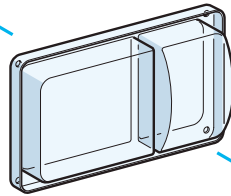

GV2 K011

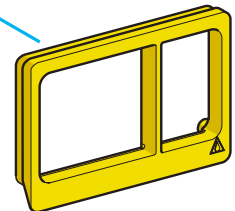
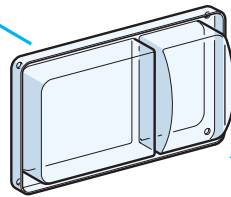

GV2 E01

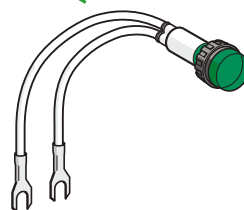

GV2 SN

Easy TeSys Power

Motor Circuit Breakers

Enclosures for Thermal-magnetic Circuit-breakers GZ1

Type	Degree of protection	Reference	Weight kg
Surface mounting, double insulated, with protective earth Sealable cover	IP 41	GV2MC01	0.290
	IP 55	GV2MC02	0.300
Flush mounting, with protective earth	IP 41 (front face)	GV2MP01	0.115
	IP 55 (front face)	GV2MP02	0.130

Front Plate

Description	Degree of protection	Sold in lots of	Unit reference	Weight kg
For direct control, through a panel, of a chassis mounted GZ1	IP 55	1	GV2CP21	0.800

Accessories Common to all Enclosures (to be Ordered Separately)

Padlocking device ⁽¹⁾ for GZ1 operator (padlocking is only possible in the "O" position)	1 to 3 padlocks Ø 4 to 8 mm	1	GV2V01	0.075
Mushroom head "Stop" pushbutton, Ø 40 mm, red	Spring return ⁽¹⁾	1	GV2K011	0.052
Sealing kit	For enclosures and front plate IP 55	10	GV2E01	0.012
Neutral terminal		100	AB1VV635UBL	0.015
Partition		50	AB1AC6BL	0.003

Description	Voltage V	Colour	Sold in lots of	Unit reference	Weight kg
Pilot light with neon bulb	380/440	Green	10	GV2SN33	0.019
		Red	10	GV2SN34	0.019
		Orange	10	GV2SN35	0.019
		Clear	10	GV2SN37	0.019

⁽¹⁾ Supplied with IP 55 sealing kit. To be fitted with enclosures GV2 M●01.

Dimensions

GZ1

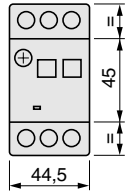
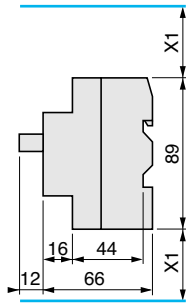

GZ1 AN, GZ1 AU, GZ1 AS

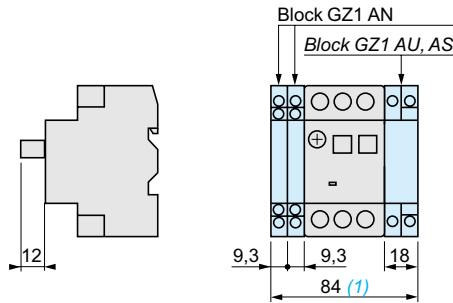

X1: electrical clearance = 40 mm for Ue y 690 V.

(1) max.

Mounting

GZ1 on 35 mm ≤ rail

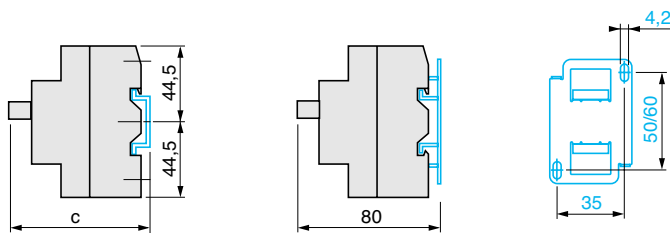

c = 78.5 on AM1 DP200 (35 x 7.5).
c = 86 on AM1 DE200 and AM1 ED200 (35 x 15).

GZ1 on pre-slotted mounting plate

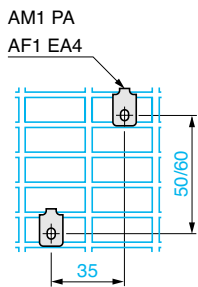

GZ1 on rails DZ5 MB201, DZ5 ME8 or GV2 AF02

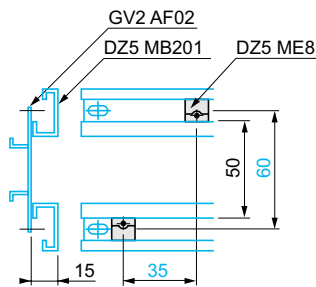

Dimensions

Surface mounting enclosure GV2 MC0●

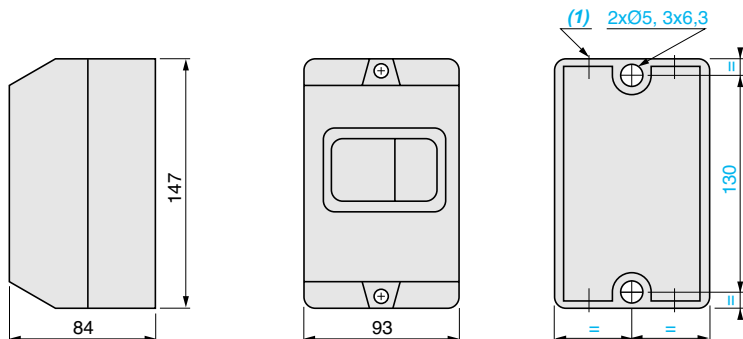

(1) 4 knock-outs for 16 mm plastic cable gland or 16 mm conduit.

Front Plate GV2 CP21

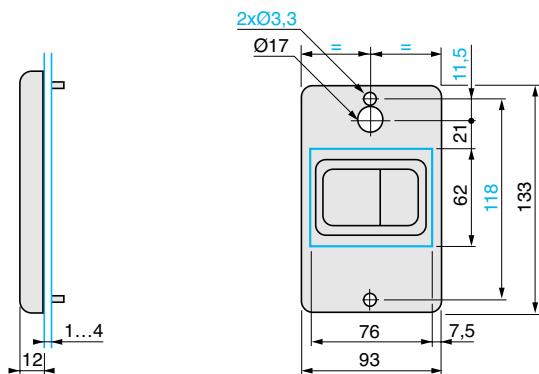

Flush Mounting Enclosures GV2 MP01 and GV2 MP02

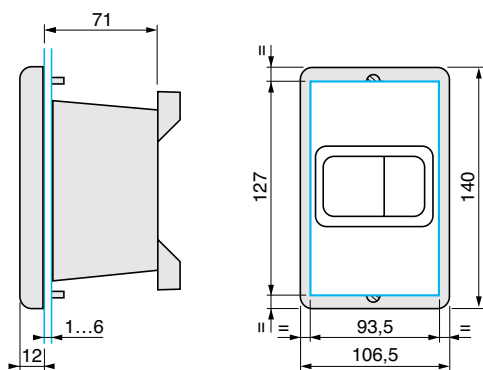



Easy TeSys - Device selection

Coordination tables

Coordination: Safety and Faster Restart after a Short Circuit

This benefit is obtained by choosing contactors with Schneider Electric guaranteed coordination.

What Exactly is Coordination?

A contactor is said to be "coordinated" with the upstream protection device when its behaviour is controlled in the event of a short circuit. This behaviour of Type 1 coordination can be:

- > Guaranteed not to pose a danger to the workforce and not to damage the installation. It is accepted that the contactor should be destroyed or repaired.

Compliance Tests

Only the very stringent certified tests performed by Schneider Electric can guarantee the behaviour described by IEC 60947-4-1.

Fuses + Contactors + Thermal Overload Relay

400 - 440 V Type 1 Coordination (IEC60947-4-1)													
Motors P(KW)	400/415 V		440 V		Switch-fuse ⁽¹⁾ Type	Fuse-link type: gG cal(A)	Fuse size	Switch-Fuse Type	Fuse-link type: aM cal(A)	Fuse size	Contactors Type	Thermal o/l relays:	
	le	P(kW)	le	le max								Type	Type
0,06	0,2	0,06	0,19	0,25	GS*G	4	T000	GS*G	2	T000	LC1E06	LRE02	0.16..0.25
0,09	0,3	0,09	0,28	0,4	GS*G	4	T000	GS*G	2	T000	LC1E06	LRE03	0.25..0.4
-	-	0,12	0,37	0,63	GS*G	4	T000	GS*G	2	T000	LC1E06	LRE04	0.4..0.63
0,12	0,44	-	-	1	GS*G	4	T000	GS*G	2	T000	LC1E06	LRE05	0.63..1
0,18	0,6	0,18	0,55	1	GS*G	4	T000	GS*G	2	T000	LC1E06	LRE05	0.63..1
0,37	1,1	0,37	1	1,6	GS*G	4	T000	GS*G	2	T000	LC1E06	LRE06	1..1,6
0,55	1,5	0,55	1,36	1,6	GS*G	6	T000	GS*G	2	T000	LC1E06	LRE06	1..1,6
0,75	1,9	0,75	1,68	2,5	GS*G	10	T000	GS*G	4	T000	LC1E06	LRE07	1,6..2,5
-	-	1,1	2,37	2,5	GS*G	10	T000	GS*G	4	T000	LC1E06	LRE07	1,6..2,5
1,1	2,7	-	-	4	GS*G	10	T000	GS*G	4	T000	LC1E06	LRE08	2,5..4
1,5	3,6	1,5	3,06	4	GS*G	16	T000	GS*G	4	T000	LC1E06	LRE08	2,5..4
2,2	4,9	2,2	4,42	6	GS*G	16	T000	GS*G	6	T000	LC1E06	LRE10	4..6
3	6,5	3	5,77	8	GS*G	20	T000	GS*G	8	T000	LC1E09	LRE12	5,5..8
4	8,5	4	7,9	9	GS*G	25	T000	GS*G	12	T000	LC1E09	LRE14	7..10
5,5	11,5	5,5	10,4	12	GS*G	32	T000	GS*G	16	T000	LC1E12	LRE16	9..13
7,5	15,5	7,5	13,7	18	GS*G	40	T000	GS*G	16	T000	LC1E18	LRE21	12..18
9	18,1	9	16,9	24	GS*G	50	T000	GS*G	25	T000	LC1E25	LRE22	16..24
11	22	11	20,1	24	GS*G	50	T000	GS*G	25	T000	LC1E25	LRE22	16..24
15	29	15	26,5	32	GS*G	80	T000	GS*G	32	T000	LC1E32	LRE32	23..32
18,5	35	18,5	32,8	40	GS*G	80	T000	GS*G	40	T000	LC1E40	LRE355	30..40
22	41	22	39	50	GS*G	100	T000	GS*G	50	T000	LC1E50	LRE357	37..50
30	55	30	51,5	65	GS*KK	125	T00	GS*KK	80	T00	LC1E65	LRE359	48..65
37	66	37	64	70	GS*KK	160	T00	GS*KK	100	T00	LC1E80	LRE361	55..70
-	-	45	76	80	GSxL	200	T0	GS*KK	100	T00	LC1E80	LRE363	63..80
45	80	-	-	95	GSxL	200	T0	GS*KK	100	T00	LC1E95	LRE365	80..104
55	97	55	90	120	GSxL	200	T0	GS*L	125	T0	LC1E120	LRE482	84..135
75	132	75	125	160	GSxN	250	T1	GS*L	160	T0	LC1E160	LRE483	124..198
90	160	90	146	200	GSxQQ	350	T2	GS*N	200	T1	LC1E200	LRE483	124..198
110	195	110	178	234	GSxQQ	400	T2	GS*N	250	T1	LC1E250	LRE484	146..234
132	230	132	215	234	GS2S	450	T3	GS*QQ	315	T2	LC1E250	LRE484	146..234
160	280	160	256	300	GS2S	630	T3	GS*QQ	400	T2	LC1E300	LRE486	208..333
200	350	200	318	400	GS2S	500	T3	GS*QQ	400	T3	LC1E400	LRE487	259...414
250	430	250	391	500	GS2S	800	T3	GS*QQ	500	T3	LC1E500	LRE488	321...513
335	574	335	523	630	GS2S	1000	T3	GS*QQ	630	T3	LC1E630	LRE489	394...630

(1) Proposed Switch-Fuse are for Blade fuse type. Other fuse type and according switch-fuse can be used.

Easy TeSys - Device selection

Coordination Tables (AC-3e)

Coordination for D.O.L Motor Starters

Fuses + Contactors + Thermal Overload Relay

400 - 440 V Type 1 Coordination (IEC60947-4-1)													
Motors					Switch-fuse ⁽¹⁾	Fuse-link type:	Fuse size	Switch-Fuse	Fuse-link type:	Fuse size	Contactors	Thermal o/l relays:	
P(KW)	400/415 V		440 V									Type	Type
	le	P(kW)	le	le max		gG cal(A)		aM cal(A)					
0,06	0,2	0,06	0,19	0,25	GS*G	4	T000	GS*G	2	T000	LC1E06	LRE02	0.16..0.25
0,09	0,3	0,09	0,28	0,4	GS*G	4	T000	GS*G	2	T000	LC1E06	LRE03	0.25..0.4
-	-	0,12	0,37	0,63	GS*G	4	T000	GS*G	2	T000	LC1E06	LRE04	0.4..0.63
0,12	0,44	-	-	1	GS*G	4	T000	GS*G	2	T000	LC1E06	LRE05	0.63..1
0,18	0,6	0,18	0,55	1	GS*G	4	T000	GS*G	2	T000	LC1E06	LRE05	0.63..1
0,37	1,1	0,37	1	1,6	GS*G	4	T000	GS*G	2	T000	LC1E06	LRE06	1..1.6
0,55	1,5	0,55	1,36	1,6	GS*G	6	T000	GS*G	2	T000	LC1E06	LRE06	1..1.6
0,75	1,9	0,75	1,68	2,5	GS*G	10	T000	GS*G	4	T000	LC1E06	LRE07	1,6..2,5
-	-	1,1	2,37	2,5	GS*G	10	T000	GS*G	4	T000	LC1E06	LRE07	1,6..2,5
1,1	2,7	-	-	4	GS*G	10	T000	GS*G	4	T000	LC1E06	LRE08	2,5..4
1,5	3,6	1,5	3,06	4	GS*G	16	T000	GS*G	4	T000	LC1E06	LRE08	2,5..4
2,2	4,9	2,2	4,42	6	GS*G	16	T000	GS*G	6	T000	LC1E06	LRE10	4..6
3	6,5	3	5,77	8	GS*G	20	T000	GS*G	8	T000	LC1E09	LRE12	5,5..8
4	8,5	4	-	9	GS*G	25	T000	GS*G	12	T000	LC1E09	LRE14	7..10
5,5	11,5	5,5	10,4	12	GS*G	32	T000	GS*G	16	T000	LC1E12	LRE16	9..13
7,5	15,5	7,5	13,7	18	GS*G	40	T000	GS*G	16	T000	LC1E18	LRE21	12..18
9	18,1	9	16,9	24	GS*G	50	T000	GS*G	25	T000	LC1E25	LRE22	16..24
11	22	11	20,1	24	GS*G	50	T000	GS*G	25	T000	LC1E25	LRE22	16..24
15	29	15	26,5	32	GS*G	80	T000	GS*G	32	T000	LC1E32	LRE32	23..32
18,5	35	18,5	32,8	40	GS*G	80	T000	GS*G	40	T000	LC1E40	LRE355	30..40
22	41	22	39	50	GS*G	100	T000	GS*G	50	T000	LC1E50	LRE357	37..50
30	55	30	51,5	65	GS*KK	125	T00	GS*KK	80	T00	LC1E65	LRE359	48..65
37	66	37	64	70	GS*KK	160	T00	GS*KK	100	T00	LC1E80	LRE361	55..70
-	-	45	76	80	GSxL	200	T0	GS*KK	100	T00	LC1E80	LRE363	63..80
45	80	-	-	95	GSxL	200	T0	GS*KK	100	T00	LC1E95	LRE365	80..104
55	97	55	90	120	GSxL	200	T0	GS*L	125	T0	LC1E120	LRE482	84..135
75	132	75	125	160	GSxN	250	T1	GS*L	160	T0	LC1E160	LRE482	84..135
90	160	90	146	200	GSxQQ	350	T2	GS*N	200	T1	LC1E200	LRE483	124..198
110	195	110	178	234	GSxQQ	400	T2	GS*N	250	T1	LC1E250	LRE483	124..198
132	230	132	215	234	GS2S	450	T3	GS*QQ	315	T2	LC1E300	LRE483	124..198
160	280	160	256	300	GS2S	630	T3	GS*QQ	400	T2	LC1E300	LRE486	208..333
200	350	200	318	400	GS2S	630	T3	GS*QQ	400	T3	LC1E400	LRE486	208..333
220	382	250	391	500	GS2S	800	T3	GS*QQ	500	T3	LC1E500	LRE487	259....414
265	455	295	460	630	GS2S	800	T3	GS*QQ	630	T3	LC1E630	LRE488	321....513

(1) Proposed Switch-Fuse are for Blade fuse type. Other fuse type and according switch-fuse can be used.

Fuses + Contactors + Thermal Overload Relay

400 - 440V Type 1 Coordination (IEC60947-4-1)																	
Motors							Switch-fuse ⁽¹⁾	Fuse-link type: gG cal(A)	Fuse size	Switch-Fuse Type	Fuse-link type: aM cal(A)	Fuse size	Line contactor Type	Delta contactor Type	Star contactor Type	Thermal o/l relays:	
P (KW)	400/415 V			440 V												Type	Type
	I _e	I _{rD}	P (KW)	I _e	I _{rD}	I _{e max}											
1,5	3,6	2,08	1,5	3,06	1,8	4	GS*G	10	T000	GS*G	4	T000	LC1E06	LC1E06	LC1E06	LRE07	1,6..2,5
2,2	4,9	2,83	2,2	4,42	2,6	6	GS*G	16	T000	GS*G	6	T000	LC1E06	LC1E06	LC1E06	LRE08	2,5..4
3	6,5	3,75	3	5,77	3,3	8	GS*G	16	T000	GS*G	8	T000	LC1E06	LC1E06	LC1E06	LRE08	2,5..4
4	8,5	4,9	4	7,9	4,6	10	GS*G	20	T000	GS*G	12	T000	LC1E06	LC1E06	LC1E06	LRE10	4..6
-	-	-	5,5	10,4	6	12	GS*G	20	T000	GS*G	16	T000	LC1E06	LC1E06	LC1E06	LRE10	4..6
5,5	11,5	6,64	-	-	-	16	GS*G	20	T000	GS*G	16	T000	LC1E09	LC1E09	LC1E09	LRE14	7..10
7,5	15,5	8,95	7,5	13,7	7,9	16	GS*G	32	T000	GS*G	16	T000	LC1E09	LC1E09	LC1E09	LRE14	7..10
9	18,1	10,5	9	16,9	9,8	20	GS*G	32	T000	GS*G	25	T000	LC1E12	LC1E12	LC1E09	LRE16	9..13
11	22	12,7	11	20,1	12	24	GS*G	50	T000	GS*G	25	T000	LC1E18	LC1E18	LC1E09	LRE21	12..18
15	29	16,7	15	26,5	15	32	GS*G	63	T000	GS*G	32	T000	LC1E18	LC1E18	LC1E09	LRE21	12..18
18,5	35	20,2	18,5	32,8	19	40	GS*G	80	T000	GS*G	40	T000	LC1E25	LC1E25	LC1E09	LRE22	16..24
22	41	23,7	22	39	23	43	GS*G	80	T000	GS*G	50	T000	LC1E25	LC1E25	LC1E09	LRE32	23..32
30	55	31,8	30	51,5	30	55	GS*KK	100	T00	GS*KK	80	T00	LC1E32	LC1E32	LC1E18	LRE35	30..38
37	66	38,1	37	64	37	70	GS*KK	125	T00	GS*KK	100	T00	LC1E40	LC1E40	LC1E40	LRE355	30..40
45	80	46,2	45	76	44	85	GSxL	160	T0	GS*KK	100	T00	LC1E50	LC1E50	LC1E40	LRE357	37..50
55	97	56	55	90	52	110	GSxL	200	T0	GS*L	125	T0	LC1E65	LC1E65	LC1E40	LRE359	48..65
75	132	76,2	75	125	72	140	GSxN	250	T1	GS*L	160	T0	LC1E80	LC1E80	LC1E65	LRE365	80..104
90	160	92,4	90	146	84	165	GSxQQ	350	T2	GS*N	200	T1	LC1E95	LC1E95	LC1E80	LRE365	80..104
110	195	113	110	178	103	210	GSxQQ	400	T2	GS*N	250	T1	LC1E120	LC1E120	LC1E95	LRE482	84..135
132	230	133	132	215	124	280	GS2S	450	T3	GS*QQ	315	T2	LC1E160	LC1E160	LC1E120	LRE483	124..198
160	280	162	160	256	148	300	GS2S	500	T3	GS*QQ	315	T2	LC1E200	LC1E200	LC1E160	LRE483	124..198
220	388	224	220	350	202	405	GS2S	630	T3	GS*QQ	400	T2	LC1E250	LC1E250	LC1E200	LRE484	146..234
265	455	-	250	391	-	-	GS2S	800	T3	GS2S	500	T3	LC1E300	LC1E300	LC1E250	LRE486	208...333

(1) Proposed Switch-Fuse are for Blade fuse type. Other fuse type and according switch-fuse can be used.

Easy TeSys - Device selection

Coordination Tables

Coordination for D.O.L Motor Starters

Thermal magnetic circuit breakers + Contactors

0.06kW to 15kW at 440V: Type 1 Coordination					
Standard power ratings of 3-phase motors 50/60 Hz in Category AC-3 / AC-3E			Circuit-breaker		Contactor
440V			Reference	Setting range of thermal trips A	Reference
P	I _e	I _q			
kW	A	kA			
0.06	0.19	50	GZ1E02	0.16...0.25	LC1E09
0.09	0.28	50	GZ1E03	0.25...0.40	LC1E09
0.12	0.37	50			
0.18	0.55	50	GZ1E04	0.40...0.63	LC1E09
0.25	0.76	50	GZ1E05	0.63...1	LC1E09
0.37	0.99	50			
0.55	1.36	50	GZ1E06	1...1.6	LC1E09
0.75	1.68	50	GZ1E07	1.6...2.5	LC1E09
1.1	2.37	50			
1.5	3.06	50	GZ1E08	2.5...4	LC1E09
2.2	4.42	50	GZ1E10	4...6.3	LC1E09
3	5.77	50			
4	7.9	50	GZ1E14	6...10	LC1E09
5.5	10.5	8	GZ1E16	9...14	LC1E12
7.5	13.7	8	GZ1E20	13...18	LC1E18
9	16.9	8			
11	20.1	6	GZ1E21	17...23	LC1E25
			GZ1E22	20...25	LC1E25
15	26.5	6	GZ1E32	24...32	LC1E32

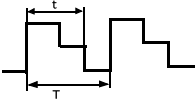
<p>Altitude</p>	<p>The rarefied atmosphere at high altitude reduces the dielectric strength of the air and hence the rated operational voltage of the contactor. It also reduces the cooling effect of the air and hence the rated operational current of the contactor (unless the temperature drops at the same time). No derating is necessary up to 3000 m.</p> <p>Derating factors to be applied above this for main pole operational voltage and current (a.c.supply) are as follows:</p> <table border="1" data-bbox="687 456 1481 600"> <thead> <tr> <th>Altitude</th> <th>3500m</th> <th>4000m</th> <th>4500m</th> <th>5000m</th> </tr> </thead> <tbody> <tr> <td>Rated operational 0.90 voltage</td> <td></td> <td>0.80</td> <td>0.70</td> <td>0.60</td> </tr> <tr> <td>Rated operational 0.92 current</td> <td></td> <td>0.90</td> <td>0.88</td> <td>0.86</td> </tr> </tbody> </table>	Altitude	3500m	4000m	4500m	5000m	Rated operational 0.90 voltage		0.80	0.70	0.60	Rated operational 0.92 current		0.90	0.88	0.86																																																
Altitude	3500m	4000m	4500m	5000m																																																												
Rated operational 0.90 voltage		0.80	0.70	0.60																																																												
Rated operational 0.92 current		0.90	0.88	0.86																																																												
<p>Ambient air temperature</p>	<p>The temperature of the air surrounding the device, measured near to the device. The operating characteristics are given:</p> <ul style="list-style-type: none"> ■ with no restriction for temperatures between -5 and +55 °C ■ with restrictions, if necessary, for temperatures between -20 and +70 °C. Please consult your local Schneider Electric office. <p>In AC-1 ($\theta \leq 70^\circ\text{C}$)</p> <table border="1" data-bbox="687 741 1481 913"> <thead> <tr> <th>Contactor Poles</th> <th>LC1E06</th> <th>LC1E09</th> <th>LC1E12</th> <th>LC1E18</th> <th>LC1E25</th> <th>LC1E32</th> <th>LC1E38</th> <th>LC1E40</th> <th>LC1E50</th> <th>LC1E65</th> <th>LC1E80</th> <th>LC1E95</th> <th>LC1E120</th> <th>LC1E160</th> <th>LC1E200</th> <th>LC1E250</th> <th>LC1E300</th> <th>LC1E400</th> <th>LC1E500</th> <th>LC1E630</th> </tr> </thead> <tbody> <tr> <td>3P</td> <td>12</td> <td>14</td> <td>14</td> <td>19</td> <td>21</td> <td>30</td> <td>30</td> <td>36</td> <td>42</td> <td>48</td> <td>60</td> <td>64</td> <td>119</td> <td>136</td> <td>153</td> <td>170</td> <td>247</td> <td>289</td> <td>425</td> <td>595</td> </tr> <tr> <td>4P</td> <td>9</td> <td>12</td> <td>14</td> <td>19</td> <td>24</td> <td>27</td> <td>30</td> <td>36</td> <td>/</td> <td>48</td> <td>55</td> <td>68</td> <td>/</td> <td>/</td> <td>/</td> <td>/</td> <td>/</td> <td>/</td> <td>/</td> <td>/</td> </tr> </tbody> </table>	Contactor Poles	LC1E06	LC1E09	LC1E12	LC1E18	LC1E25	LC1E32	LC1E38	LC1E40	LC1E50	LC1E65	LC1E80	LC1E95	LC1E120	LC1E160	LC1E200	LC1E250	LC1E300	LC1E400	LC1E500	LC1E630	3P	12	14	14	19	21	30	30	36	42	48	60	64	119	136	153	170	247	289	425	595	4P	9	12	14	19	24	27	30	36	/	48	55	68	/	/	/	/	/	/	/	/
Contactor Poles	LC1E06	LC1E09	LC1E12	LC1E18	LC1E25	LC1E32	LC1E38	LC1E40	LC1E50	LC1E65	LC1E80	LC1E95	LC1E120	LC1E160	LC1E200	LC1E250	LC1E300	LC1E400	LC1E500	LC1E630																																												
3P	12	14	14	19	21	30	30	36	42	48	60	64	119	136	153	170	247	289	425	595																																												
4P	9	12	14	19	24	27	30	36	/	48	55	68	/	/	/	/	/	/	/	/																																												
<p>Rated operational current (Ie)</p>	<p>This is defined taking into account the rated operational voltage, operating rate, utilisation category and ambient temperature around the device.</p>																																																															
<p>Conventional thermal current (Ith) ⁽¹⁾</p>	<p>The current which a closed contactor can sustain for a minimum of 8 hours without its temperature rise exceeding the limits given in the standards.</p>																																																															
<p>Permissible short-time rating</p>	<p>The current which a closed contactor can for a short time after a period of no load, without dangerous overheating.</p>																																																															
<p>Rated operational voltage (Ue)</p>	<p>This is the voltage value which, in conjunction with the rated operational current, determines the use of the contactor or starter, and on which the corresponding tests and the utilisation category are based. For 3-phase circuits, it is expressed as the voltage between phases.</p>																																																															
<p>Rated control circuit voltage (Uc)</p>	<p>The rated value of the control circuit voltage, on which the operating characteristics are based. For a.c. applications, the values are given for a sinusoidal wave form (less than 5% total harmonic distortion).</p>																																																															
<p>Rated insulation voltage (Ui)</p>	<p>This is the voltage value used to define the insulation characteristics of a device and referred to in dielectric tests determining leakage paths. As the specifications are not identical for all standards, the rated value given for each of them is not necessarily the same.</p>																																																															
<p>Rated impulse withstand voltage (Uimp)</p>	<p>The peak value of a voltage surge which the device is able to withstand without breaking down.</p>																																																															
<p>Rated operational power (expressed in kW)</p>	<p>The rated power of the standard motor which can be switched by the contactor, at the rated operational voltage.</p>																																																															
<p>Rated breaking capacity ⁽²⁾</p>	<p>This is the current value which the contactor can break in accordance with the breaking conditions specified in the IEC standard.</p>																																																															
<p>Rated making capacity ⁽²⁾</p>	<p>This is the current value which the contactor can make in accordance with the making conditions specified in the IEC standard.</p>																																																															
<p>On-load factor (m)</p>	<p>This is the ratio between the time the current flows (t) and the duration of the cycle (T).</p>  <p>$m = t/T$</p> <p>Cycle duration: duration of current flow + time at zero current.</p>																																																															
<p>Pole impedance</p>	<p>The impedance of one pole is the sum of the impedance of all the circuit components between the input terminal and the output terminal. The impedance comprises a resistive component (R) and an inductive component ($X = L\omega$). The total impedance therefore depends on the frequency and is normally given for 50 Hz. This average value is given for the pole at its rated operational current.</p>																																																															
<p>Electrical durability</p>	<p>This is the average number of on-load operating cycles which the main pole contacts can perform without maintenance. The electrical durability depends on the utilisation category, the rated operational current and the rated operational voltage.</p>																																																															
<p>Mechanical durability</p>	<p>This is the average number of no-load operating cycles (i.e. with zero current flow through the main pole) which the contactor can perform without mechanical failure.</p>																																																															

(1) Conventional thermal current, in free air, conforming to IEC standards.
 (2) For a.c. applications, the breaking and making capacities are expressed by rms value of the symmetrical component of the short-circuit current. Taking into account the maximum asymmetry which may exist in the circuit, the contacts therefore have to withstand a peak asymmetrical current which may be twice the rms symmetrical component.

Note: these definitions are extracted from standard IEC 60947-1.

Contactor utilisation categories conforming to IEC 60947-4

The standard utilisation categories define the current values which the contactor must be able to make or break.

These values depend on:

- the type of load being switched: squirrel cage or slip ring motor, resistors
- the conditions under which making or breaking takes place: motor stalled, starting or running, reversing, plugging.

a.c. applications**■ Category AC-1:**

This category applies to all types of a.c. load with a power factor equal to or greater than 0.95.

Examples: heating, lighting, distribution.

■ Category AC-3:

This category applies to squirrel cage motors with breaking during normal running of the motor. On closing, the contactor makes the starting current, which is about 7 times the rated current of the motor.

On opening, it breaks the rated current drawn by the motor; at this point, the voltage at the contactor terminals is about 20 % of the mains supply voltage. Breaking is light. For example: all standard squirrel cage motors: lifts, escalators, conveyor belts, bucket elevators, compressors, pumps, mixers, air condition units, etc...

■ Category AC-3e:

This category applies to high-efficiency IE3/ IE4 squirrel cage motors with breaking during normal running of the motor.

- On closing, the contactor makes the starting current, which is about 5 to 9 times the rated current of the motor.
- On opening, it breaks the rated current drawn by the motor.

Application examples: all high-efficiency IE3/ IE4 squirrel cage motors typically used for elevators and escalators, machine tools, conveyor belts, compressors, pumps, mixers, air conditioning units, etc...

Technical information

Current of Asynchronous Squirrel Cage Motors at Nominal Load

3-phase 4-pole Motors

Current values for power in kW

Rated operational power (1)	Indicative rated operational current values at:			
	230 V	400 V	500 V	690 V
kW	A	A	A	A
0.06	0.35	0.2	0.16	0.12
0.09	0.52	0.3	0.24	0.17
0.12	0.7	0.44	0.32	0.23
0.18	1	0.6	0.48	0.35
0.25	1.5	0.85	0.68	0.49
0.37	1.9	1.1	0.88	0.64
0.55	2.6	1.5	1.2	0.87
0.75	3.3	1.9	1.5	1.1
1.1	4.7	2.7	2.2	1.6
1.5	6.3	3.6	2.9	2.1
2.2	8.5	4.9	3.9	2.8
3	11.3	6.5	5.2	3.8
4	15	8.5	6.8	4.9
5.5	20	11.5	9.2	6.7
7.5	27	15.5	12.4	8.9
11	38	22	17.6	12.8
15	51	29	23	17
18.5	61	35	28	21
22	72	41	33	24
30	96	55	44	32
37	115	66	53	39
45	140	80	64	47
55	169	97	78	57
75	230	132	106	77
90	278	160	128	93
110	340	195	156	113
132	400	230	184	134
160	487	280	224	162
200	609	350	280	203
250	748	430	344	250
315	940	540	432	313
355	1061	610	488	354
400	1200	690	552	400
500	1478	850	680	493
560	1652	950	760	551
630	1844	1060	848	615
710	2070	1190	952	690
800	2340	1346	1076	780
900	2640	1518	1214	880
1000	2910	1673	1339	970

(1) Values conforming to standard IEC60072-1 (at 50Hz).

Note: These values are given as a guide. They may vary depending on the type of motor, its polarity and the manufacturer.

Standardisation

Conformity to standards

Schneider Electric products satisfy, in the majority of cases, European (for example: CENELEC) or international (IEC) standards. These product standards precisely define the performance of the designated products (such as IEC 60947 for low voltage equipment).

When used correctly, as designated by the manufacturer and in accordance with regulations and correct practices, these products will allow users to build equipment, machine systems or installations that conform to their appropriate standards (for example: IEC 60204-1, relating to electrical equipment used on industrial machines). Schneider Electric is able to provide proof of conformity of its production to the standards it has chosen to comply with, through its quality assurance system. On request, and depending on the situation, Schneider Electric can provide the following:

- a declaration of conformity
- a certificate of conformity
- a homologation certificate or approval, in the countries where this procedure is required or for particular specifications, such as those existing in the merchant navy.

Code	Certification authority		Country
	Name	Abbreviation	
EAC	Eurasian Conformity	EAC	Russia
IEC	International Electrotechnical Commission	IEC	Worldwide

Regulations

European Directives

Opening up of European markets assumes harmonisation of the regulations pertaining to each of the member countries of the European Union.

The purpose of the European Directive is to eliminate obstacles hindering the free circulation of goods within the European Union, and it must be applied in all member countries. Member countries are obliged to transcribe each Directive into their national legislation and to simultaneously withdraw any contradictory regulations.

The Directives, in particular those of a technical nature which concern us, only establish the objectives to be achieved, referred to as "essential requirements".

The manufacturer must take all the necessary measures to ensure that his products conform to the requirements of each Directive applicable to his production.

As a general rule, the manufacturer certifies conformity to the essential requirements of the Directive(s) for his product by affixing the CE marking.

The CE marking is affixed to Schneider Electric brand products concerned, in order to comply with French and European regulations.

Significance of the CE marking

- The CE marking affixed to a product signifies that the manufacturer certifies that the product conforms to the relevant European Directive(s) which concern it; this condition must be met to allow free distribution and circulation within the countries of the European Union of any product subject to one or more of the E.U. Directives.
- The CE marking is intended solely for national market control authorities.
- The CE marking must not be confused with a conformity marking.

European Directives (continued)

For electrical equipment, only conformity to standards signifies that the product is suitable for its designated function, and only the guarantee of an established manufacturer can provide a high level of quality assurance.

For Schneider Electric brand products, one or several Directives are likely to be applicable, depending on the product, and in particular:

- the Low Voltage Directive 2014/35/EU: the CE marking relating to this Directive has been compulsory since 16th January 2007.
- the Electromagnetic Compatibility Directive 2014/30/EU.

Note

For further details on a specific product, please refer to the "Characteristics" pages in this catalogue or consult your Regional Sales Office.



Life Is On



Schneider Electric Industries SAS

35, rue Joseph Monier
CS 30323
F - 92506 Rueil Malmaison Cedex

RCS Nanterre 954 503 439
Capital social 896 313 776 €
www.se.com

11-2025

© 2025 - Schneider Electric. All Rights Reserved.

All trademarks are owned by Schneider Electric Industries SAS or its affiliated companies.

Document reference LVED212071EN

This document has been
printed on recycled paper

